

Unica

Un confortevole abbraccio durante la degenza terapeutica



POLTRONA

Uso frequente

Chemioterapia

Terapia Infusionale

Day Hospital

Donazione sangue

Dialisi

Polifunzionali





**PULSANTIERA 10 TASTI
CON 2 MEMORIE**

Vantaggi

- Telaio antiribaltamento che assicura stabilità in ogni condizione operativa.
- Telaio verniciato con polveri epossidiche termoindurenti arricchite con antibatterico con vasto assortimento colori. Personalizzazione colore come da campionario.
- Superficie anatomica, estremamente ergonomica ed avvolgente che assicura il massimo comfort.
- Imbottitura dei cuscini realizzati in poliuretano espanso indeformabile.
- Due cuscini separati schienale e seduta/gambe, funzionali per: postura eccellente, ergonomia ed effetto preventivo delle lesioni da decubito.
- Configurabile con numerosi accessori funzionali ed esclusivi (consultare il catalogo accessori).
- Proprietà del rivestimento: antibatterico, ignifugo classe 1M, antimicotico, ecologico, latex free/senza ftalati e resistente.
- Portata massima 150 kg.

Dotazioni di serie

- Telaio in acciaio verniciato realizzato con polveri termoindurenti arricchite con antibatterico. Colore personalizzabile - Scheda colori a pag. 4.
- Piano suddiviso in 3 sezioni: schienale, seduta e gambe.
- Movimentazione simultanea e indipendente delle sezioni schienale e gambe tramite 2 motori - Codice dotazione AC12.
- Nr. 4 ruote durevoli (2 girevoli con freno e due fisse) realizzate in acciaio inossidabile Ø 60 mm.
- Tutte le movimentazioni della poltrona sono comandate tramite pulsantiera perimetrale dotata di cavo spiralato da 3,5 m. La pulsantiera è di facile utilizzo poiché realizzata con grandi pittogrammi a rilievo e risulta adatta anche per pazienti ipovedenti. La pulsantiera è dotata di 10 tasti con 2 memorie. Per la sicurezza dei pazienti la pulsantiera è fornita di chiave per inibizione dei comandi - Codice dotazione AC34P. Isolamento IP66.
- Cuscini realizzati in soft foam.
- Rivestimento ecopelle ignifugo UNI 9175/87 e 9175FA-1/94 classe 1M - Codice dotazione AC87/1.



Movimentazioni

ESTENSIONE/ELEVAZIONE
MOTORIZZATA E SINCRONIZZATA
DELLA SEZIONE GAMBALE



POSIZIONE ANTISHOCK

















Scheda colori



COLORI TELAIO

Tutta la struttura della poltrona è protetta da vernici epossidiche termoindurenti. Le vernici sono arricchite su richiesta di antibatterico. Se non specificato il dispositivo sarà realizzato bianco 9010.

 Codice 2004	 Codice 5012	 Codice 7035
 Codice 3020	 Codice 6027	 Codice 9005
 Codice 1018	 Codice 6018	 Codice 9010
 Codice 1021	 Codice 7001	 Codice 4010
 Codice 5010	 Codice 9006	

COLORI PER RIVESTIMENTO STANDARD

 Codice 5947	 Codice 0872	 Codice 0014
 Codice 5948	 Codice 4947	 Codice 0027
 Codice 0680	 Codice 1944	 Codice 0006
 Codice 0508	 Codice 4008	 Codice 0346
 Codice 0041	 Codice 1946	 Codice 016043
 Codice 0064	 Codice 4933	 Codice 011499
 Codice 0055	 Codice 0430	 Codice 015815
 Codice 1816	 Codice 0151	 Codice 015814
 Codice 0833	 Codice 0667	 Codice 016042

COLORI PER RIVESTIMENTO SILICONICO (CON MAGGIORAZIONE DI PREZZO) CODICE ACCESSORIO AC87





















 Codice 7039.08	 Codice 7039.14	 Codice TH.439
 Codice 7039.06	 Codice TH.513	 Codice TH.438
 Codice 7039.17	 Codice TH.511	 Codice TH.322
 Codice 7039.20	 Codice TH.305	 Codice TH.224
 Codice 7039.10	 Codice TH.378	 Codice 312
 Codice 7039.19	 Codice TH.300	 Codice TH.226
 Codice 7039.13	 Codice TH.510	



Tabella dimensioni

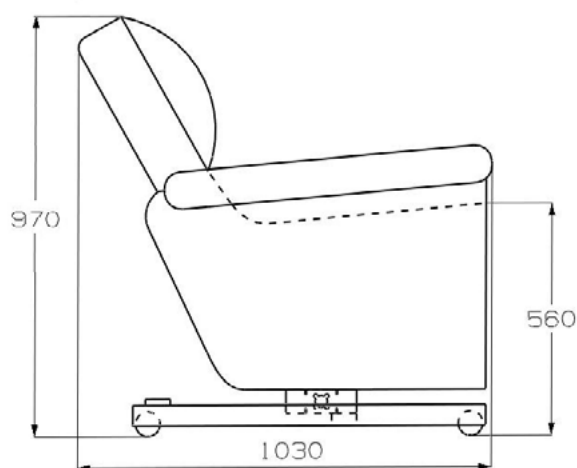
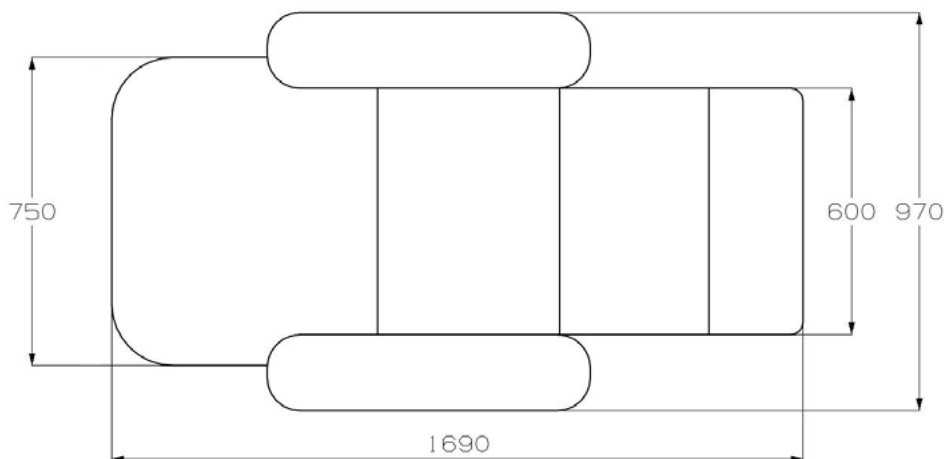

Scheda tecnica

Codice CND	Z129008
N. progressivo/R	359266/R
Codice Prodotto	GB0006.SP
Destinazione d'uso	Poltrona polifunzionale
Produttore	GARDHEN BALANCE SRL
Peso totale	65 kg
Ruote inossidabili girevoli	Nr. 4 Ø 60 mm di cui 2 girevoli e due fisse
Alimentazione	100 - 240 Vac 50/60 Hz
Motori elettrici	Bassa tensione (24 V)
Assorbimento max	4A
Isolamento	IP44
Portata Massima	150 kg
Carico di lavoro sicuro	185 kg

TIPOLOGIA CAVO DI ALIMENTAZIONE



Tipo F - Schuko



Tipo L - 16A

Per le certificazioni fare riferimento a quanto specificato nella Sezione "Certificazioni e Sistema qualità"

Le immagini riprodotte in questa scheda sono puramente indicative. È facoltà del produttore apportare ai progetti modifiche senza alcun preavviso. Per l'identificazione delle dotazioni di serie e per la scelta di eventuali ulteriori componenti riferirsi al catalogo accessori e/o alle proposte commerciali. In caso di dati discordanti fa fede il contenuto delle proposte commerciali.

Dep. 74 rev. 20/12/2021