

Work happily



V1.2

naggura'swop

[naggura.com](http://naggura.com)

# I nostri prodotti

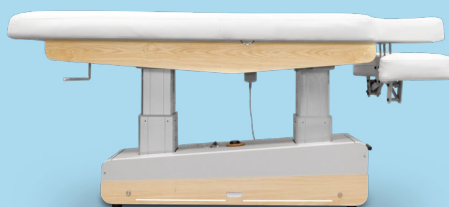

Swop S4 UP SPA è un lettino elettrico a 3 sezioni con materasso tutto d'un pezzo, doppia colonna, rivestimento in legno, ruote, LEDs, 3 posizioni di memoria e funzione reset, braccioli regolabili TwinLift e riscaldamento.

Legno, metallo o PMMA



## Collezioni dei pannelli

Nordic  
METALLO

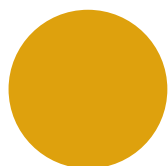

Yellow

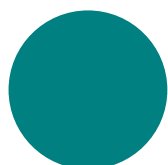

Blue

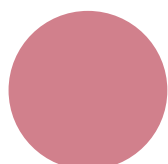

Pink

Foll  
METALLO

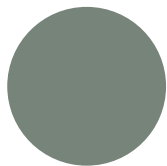

Ash

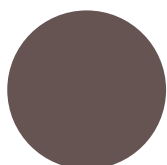

Clay

Iron  
METALLO

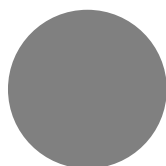

Inox

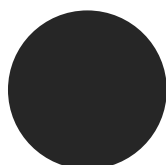

Black

Om  
LEGNO



Oak



Wenge

Techno  
PMMA



Fluor

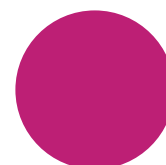

Fuxia



Ice

# SWOP S4 UP SPA



## Dimensioni

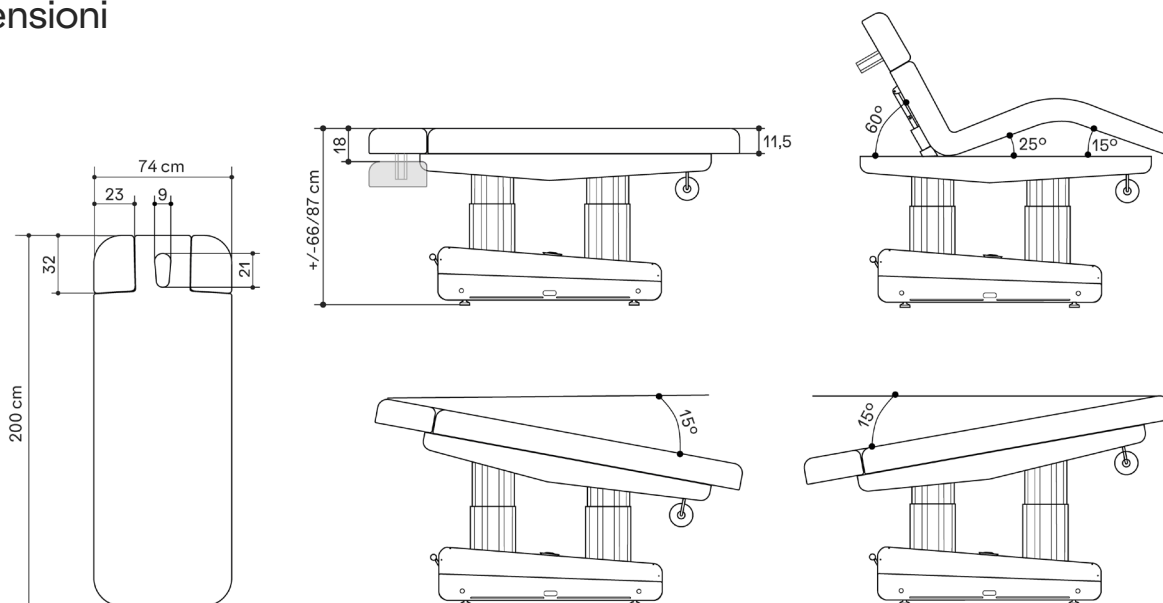

## Caratteristiche tecniche

### MOTORI

4 motori (altezza, inclinazione, schienale e poggiatesta)

### DIMENSIONI (LUNGHEZZA X LARGHEZZA)

200 x 74 cm

### ALTEZZA (MINIMA E MASSIMA)

66/87 cm

### PESO

135 kg

### SPESSORE

11,5 cm (10 cm lattice e 1,5 cm base in legno)

### DENSITÀ

30 kg/m<sup>3</sup>

### CAPACITÀ DI CARICO

300 kg

### FUNZIONAMENTO

Telecomando (incluso)/  
Pedaliera (opzionale)

### ALIMENTAZIONE ELETTRICA

230 V - 50/60 Hz

### POTENZA MASSIMA

2 A

### MOTORE ELETTRICO

6.000 N

### CARATTERISTICHE

Sistema di braccioli regolabili TwinLift  
Riscaldamento  
Portarotoli, Ruote

### RIVESTIMENTO

Rivestimento senza cuciture con bordi arrotondati.

Rivestimento Naggura Skin: 100% Mix vinilico in bianco.

Resistenza all'abrasione: >250.000 cicli. Protezione contro germi e raggi UV