

Lemi[®]
ITALIAN WELLNESS EQUIPMENT



GINECOLOGIA

GYNAECCOLOGY



standard version / versione standard



version with removable legrest / versione con gamba estraibile



COD. 302

Gyno is specifically designed for diagnostics, gynaecological, ultrasound and colposcopic examinations. Equipped with standard anatomic mattress. Upon request, the version with removable legrest allows the chair to become a functional examination bed.

Gyno è specificamente progettato per esami diagnostici, ginecologici, ecografici e colposcopici. Dotato di materasso anatomico standard. Su richiesta, la versione con poggiambraccia rimovibile consente alla poltrona di diventare un lettino funzionale.

Focus on

- 3 motors for height, backrest and trendelenburg adjustment
- Foot pedal control
- Automatic reset function
- "Easy-to-clean" mattress
- Wide selection of class 1IM fire-resistant coverings
- Removable legrest available upon request
- Standard version includes: stainless steel tray for organic waste, thigh support couple, seat guides couple, fixed clamps couple, stainless steel handles and roll holder

- 3 motori per regolazione di altezza, schiena e trendelenburg
- Pedaliera
- Funzione di azzeramento automatico
- Materasso "easy-to-clean"
- Ampia scelta di rivestimenti ignifughi classe 1 IM
- Gamba estraibile disponibile su richiesta
- La versione standard include: vassoio in acciaio inossidabile per rifiuti organici, coppia di reggicoste, coppia guide seduta, coppia morsetti fissi, maniglie in acciaio inossidabile e portarotolo

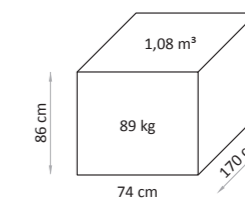
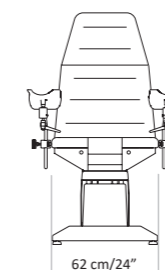
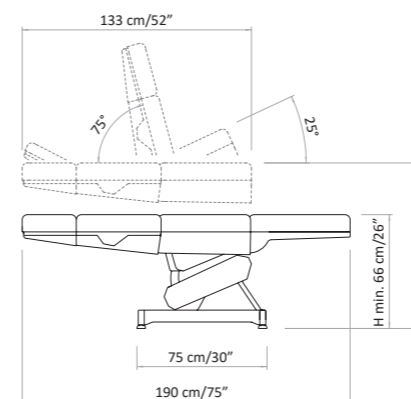

MOVEMENTS

3 electric movements: height, back rest and trendelenburg
1 manual movement: head rest adjustment

MOVIMENTI

3 movimenti elettrici: altezza, schiena e trendelenburg
1 movimento manuale: regolazione testa



Anatomic seat with a practical stainless steel bowl
Seduta incava con pratica vaschetta inox



Electric height 66-96 cm
Altezza elettrica (26" - 38 ")



Extractable leg rests available upon request in order to obtain the lying position.

Gambe estraibili a richiesta per ottenere la posizione di lettino



75°

Electric back rest
Schiena elettrica



25°

Electric Trendelenburg
Trendelenburg elettrico



BASE CUSTOMIZATION

We provide a thermoformed ABS base, completely closed to prevent any infiltration of powders or liquids. It is a very hard material, scratch-proof resistant and easy-to-clean.

PERSONALIZZAZIONE BASE

Forniamo una base in ABS termoformato, completamente chiuso per evitare qualsiasi infiltrazione di polveri o liquidi. È un materiale molto duro, resistente ai graffi e facile da pulire.

MATTRESS CUSTOMIZATION

Nefos is the exclusive upholstery line by Lemi. The innovative material and its special finishing touch guarantee easy-cleaning and hygiene. Its extraordinary structural qualities will persist through the years. An incredibly elastic texture enhances the memory foam mattress softness and quality at its best, giving Spa Clients a complete and satisfying wellness experience.

PERSONALIZZAZIONE MATERASSO

Nefos è la linea di rivestimento esclusive di Lemi. L'innovativo materiale e il suo speciale tocco di finitura garantiscono una facile pulizia e igiene. Le sue straordinarie qualità strutturali permangono nel corso degli anni. Una texture incredibilmente elastica migliora al massimo la morbidezza e la qualità del materasso in Memory Foam, dando ai clienti di Spa un'esperienza di benessere completa e soddisfacente.

Available finishing for GYNO Finiture disponibili per GYNO



White
Bianco



Grey
Grigio



Black
Nero

NEFOS COLORS

COLORI NEFOS



ACCESSORIES UPON REQUEST ACCESSORI SU RICHIESTA

All Medical chairs have a standard setting customizable upon request.

Tutte le poltrone Medicali hanno una configurazione standard personalizzabile su richiesta.



Handset control
Pulsantiera



Heel support couple
(fixed with fix clamp and guides on the seat)
Coppia reggitalone
(da fissare con morsetti fissi e guide sulla seduta)



Wireless foot pedal control
(NO foot pedal with cable NO remote control)
Pedaliera wireless (NON compatibile con il pedale a filo e con la pulsantiera)



Curtain holder
(fixed with rotatable clamp and guides on the seat)
Reggitelo
(da fissare con morsetto girevole e guide schiena)



Wheels with brake
Ruote con freno



Colposcope support
Supporto colposcopio

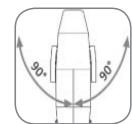

Option 180° rotation
Opzione rotazione 180°



Leg support
Gamba estraibile

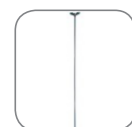

I.V. Rod
(fixed with rotatable clamp and guides on the back)
Asta portaflebo (da fissare con morsetto girevole e guide schiena)



UK cable
Cavo UK



Medical armrest couple (to be fixed with rotatable clamp and guides on the back)
Coppia braccioli medicali
(da fissare con morsetti girevoli e guide schiena)



Australian cable
Cavo Australia



Back guide couple
Coppia guide schiena



Customization with logo
Personalizzazione con logo



Rotatable clamps couple
Coppia morsetti girevoli

TECHNICAL REQUIREMENTS

CARATTERISTICHE TECNICHE

ELECTRIC REQUIREMENTS / CARATTERISTICHE ELETTRICHE

VOLTAGE VOLTAGGIO	FREQUENCY FREQUENZA	ABSORPTION ASSORBIMENTO	TRANSFORMER TRASFORMATORE	PROTECTION RATING GRADO DI PROTEZIONE	ELECTRIC SYSTEM CONFORMS TO CEI NORMS IMPIANTO ELETTRICO a norme CEI	CONTROL BOX CENTRALINA
230/110V ac	50/60 Hz	0,70 A max	120 Va	IP 54	4	class II classe II

TECHNICAL SPECIFICATION / SPECIFICHE TECNICHE

MINIMUM HEIGHT: 66 CM / 26"

MAXIMUM HEIGHT: 96 CM / 38"

ANGLE OF INCLINATION TRENDELENBURG: 25°

ANGLE OF INCLINATION BACK REST: 75°

MATTRESS LENGTH: 133 CM / 52"

MATTRESS LENGTH WITH LEGREST: 190 CM / 75"

MATTRESS WIDTH: 62 CM / 24"

ROTATION: 180°

LATEX-FREE, NON-TOXIC AND NON-CARCINOGENIC MATERIALS

FIRE-RESISTANT UPHOLSTERY: UNI 9175 CLASS I M

ALTEZZA MINIMA: 66 CM

ALTEZZA MASSIMA: 96 CM

ANGOLO INCLINAZIONE TRENDELENBURG: 25°

ANGOLO INCLINAZIONE SCHIENA: 75°

LUNGHEZZA MATERASSO: 133 CM

LUNGHEZZA MATERASSO GAMBE ESTESE: 190 CM

LARGHEZZA MATERASSO: 62 CM

ROTAZIONE: 180°

MATERIALI PRIVI DI LATTICE, ATOSSICI E NON CANCEROGENI

RIVESTIMENTO IGNIFUGO: UNI 9175 CLASS I M

WARRANTY / GARANZIA

STRUCTURE: 10 YEARS

MOTORS AND CONTROL: 2 YEARS

CUSHION: 5 YEARS

STRUTTURA: 10 ANNI

MOTORI E CONTROLLI: 2 ANNI

MATERASSO: 5 ANNI

REGULATIONS

All Equipment is  marked

Electrical equipment and beds

Directive 2006/42/CE (Machinery Directive) and national regulations
Directive 2004/108/CE (Electromagnetic Compatibility Directive) and national regulations.

Hydraulic equipment and beds

Directive 2006/42/CE (Machinery Directive) and national regulations

Images

The images are for illustrative purposes only and may not reflect the actual image of the product.

NORME

Tutte le attrezzature sono a marchio 

Attrezzature e lettini elettrici

Direttiva 2006/42/CE (Direttiva Macchine) e disposizioni nazionali di attuazione
Direttiva 2004/108/CE (Direttiva Compatibilità elettromagnetica) e disposizioni nazionali di attuazione.

Attrezzature e lettini idraulici

Direttiva 2006/42/CE (Direttiva Macchine) e disposizioni nazionali di attuazione

Immagini

Le immagini hanno valore puramente illustrativo e possono non rispecchiare l'immagine reale del prodotto.

Lemi[®]
ITALIAN WELLNESS EQUIPMENT

Brusaferrì & C srl

Via Mara Maretti Soldi, 13
26011 Casalbuttano (CREMONA) ITALY
Phone +39-0374-363069 Fax +39-0374-363071
info@lemigroup.it service@lemigroup.it

www.lemigroup.it