

















USER MANUAL
MS5900
Infant Scale



Please keep the instruction manual at hand all the time for future reference.

Explanation of Graphic Symbols on Label/Packaging

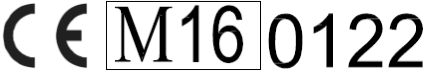
	<p>Caution, consult accompanying documents before use</p>		<p>Separate collection for waste of electrical and electronic equipment, in accordance with Directive 2002/96/EC</p>
	<p>Manufacturer of medical device</p>		<p>Manufacturing year of medical device</p>
	<p>Carefully read user manual before installation and usage, and follow instructions for use.</p>		<p>Medical electrical equipment part with Type B applied part</p>
	<p>Device catalogue number</p>		<p>Authorized representative in the European Community</p>
	<p>Manufacturer's batch or lot number</p>		<p>Device is a medical device</p>
	<p>Serial number</p>		<p>Unique Device Identifier</p>
		<p>Device conforms to 93/42/EEC as amended by 2007/47/EC Medical Device Directive. Four digit number refers to Notified Body.</p>	
		<p>Device complies with International Organization of Legal Metrology (Class III) requirements (verified models only)</p>	
		<p>Device complies with EC directives (verified models only)</p> <p>M: Conformity label in compliance with Directive 2014/31/EU for non-automatic weighing instruments</p> <p>16: Year in which conformity verification was performed and the CE label was applied. (ex: 16=2016)</p> <p>0122: Refers to Notified Body for metrology</p>	

Copyright Notice

Charder Electronic Co., Ltd.

No.103, Guozhong Rd., Dali Dist., Taichung City 41262 Taiwan

Tel: +886-4-2406 3766

Fax: +886-4-2406 5612

Website: www.chardermedical.com E-mail: info_cec@charder.com.tw

Copyright© Charder Electronic Co., Ltd. All rights reserved.

This user manual is protected by international copyright law. All content is licensed, and usage is subject to written authorization from Charder Electronic Co., Ltd. (hereinafter Charder) Charder is not liable for any damage caused by a failure to adhere to requirements stated in this manual. Charder reserves the right to correct misprints in the manual without prior notice, and modify the exterior of the device for quality purposes without customer consent.



Charder Electronic Co., Ltd.
No. 103, Guozhong Rd., Dali Dist.,
Taichung City, 41262 Taiwan

CONTENTS

I. Safety Notes	5
A. General Information	5
B. EMC Guidance and Manufacturer's Declaration	8
II. Installation	12
A. Height Measure Attachment	12
B. Inserting Batteries	15
C. Using AC Adapter.....	15
III. Indicator and Key Functions	16
IV. Using Device	17
A. Basic Operation	17
B. Recall	17
C. Milk Intake	17
D. Printing	19
VII. Wireless Connection	20
A. Turning on Wi-Fi	20
B. Connecting device wirelessly	20
VI. Device Setup	24
VII. Troubleshooting	26
VIII. Product Specifications	28
IX. Declaration of Conformity	32



I. Safety Notes

A. General Information

Thank you for choosing this Charder Medical device. It is designed to be easy and straightforward to operate, but if you encounter any problems not addressed in this manual, please contact your local Charder service partner.

Before beginning operation of the device, please read this user manual carefully, and keep it in a safe place for reference. It contains important instructions regarding installation, proper usage, and maintenance.

Intended Use

This device is intended to measure the weight of babies and toddlers, for diagnosis of weight-related issues by professionals.

General Handling

- Device should be placed on stable, flat, solid, non-slippery table.
- Usage on soft surfaces (ex: carpet) may result in inaccurate results.
- Ensure all parts are properly locked and tightened before operating the device.
- Device is intended to measure one subject at a time.

Safety Instructions

- Batteries should be kept away from children. If swallowed, promptly seek medical assistance.
- Expected service life: 5 years.
- Always comply with appropriate regulations when using electrical components under increased safety requirements.
- Ensure voltage marked on power supply matches mains power supply.
- The device is intended for indoor use only.
- Observe permissible ambient temperatures for use

Environmental

- All batteries contain toxic compounds; batteries should be disposed of via designated competent organizations. Batteries should not be incinerated.

Cleaning

- Device surface should be cleaned using alcohol-based wipes. Corrosive cleansing liquids should not be used. Pressure-washers should not be used.

- Do not use large amounts of water when cleaning the device, as it may cause damage to the internal electronics.
- Always disconnect device from mains power before cleaning.

Maintenance

- Device does not require routine maintenance. However, regular checking of accuracy is recommended; frequency to be determined by level of use and state of device. If results are inaccurate, please contact local distributor.

Warranty/Liability

- The period of warranty shall be eighteen (18) months, beginning on the date of purchase. Please retain your receipt as proof of purchase.
- No responsibility shall be accepted for damage caused through any of the following reasons: unsuitable or improper storage or use, incorrect installation or commissioning by the owner or third parties, natural wear and tear, changes or modifications, incorrect or negligent handling, chemical, electrochemical, or electrical interference.
- All maintenance, technical inspections, and repairs should be conducted by an authorized Charder service partner, using original Charder accessories and spare parts. Charder is not liable for any damages arising from improper maintenance or usage.

Disposal

- This product is not to be treated as regular household waste, but should be taken to a designated collection points for electronics. Further information should be provided by local waste disposal authorities.



Warning

- Only the original adapter should be used with the device. Using an adapter other than the one provided by Charder may cause malfunction.
- Do not touch the power supply with wet hands.
- Do not crimp the power cable, and avoid sharp edges.
- Do not overload extension cables connected to the device.
- Route cables carefully, to avoid tripping.
- Keep device away from liquids.
- Do not remove the plug by yanking on the cable.
- Use only a correctly wired (100-240VAC) outlet, and do not use a multiple outlet extension cable.

-
- Do not under any circumstances dismantle or alter the device, as this could result in electric shock or injury as well as adversely affect the precision of measurements.
 - Do not place the device in direct sunlight, or in close proximity to an intense heat source. Excessively high temperatures may damage the internal electronics.

Incident Reporting

Any serious incident that has occurred in relation to the device should be reported to the manufacturer, EU representative (if device is used in EU member state), and competent authority of user/subject's member state.

B. EMC Guidance and Manufacturer's Declaration

Guidance and manufacturer's declaration-electromagnetic emissions		
The MS5900 Infant Scale is intended for use in the electromagnetic environment specified below. The customer or the user of the device should assure that it is used in such an environment.		
Emission test	Compliance	Electromagnetic environment-guidance
RF emissions CISPR 11	Group 1	The device uses RF energy only for its internal function. Therefore, its RF emissions are very low and are not likely to cause any interference in nearby electronic equipment.
RF emissions CISPR 11	Class B	The device is suitable for use in all establishments, including domestic establishments and those directly connected to the public low-voltage power supply network that supplies buildings used for domestic purposes.
Harmonic emissions IEC 61000-3-2	Class A	
Voltage fluctuations /flicker emissions IEC 61000-3-3	Compliance	

Guidance and manufacturer's declaration-electromagnetic immunity

The MS5900 Infant Scale is intended for use in the electromagnetic environment specified below. The customer or the user of the device should assure that it is used in such an environment.

Immunity test	IEC 60601 test level	Compliance level	Electromagnetic environment-guidance
Electrostatic discharge(ESD) IEC 61000-4-2	<u>± 8 kV contact</u> <u>± 2 kV, ± 4 kV,</u> <u>± 8 kV, ± 15 kV</u> <u>air</u>	<u>± 8 kV contact</u> <u>± 2 kV, ± 4 kV,</u> <u>± 8 kV, ± 15 kV</u> <u>air</u>	Floors should be wood, concrete or ceramic tile. If floors are covered with synthetic material, the relative humidity should be at least 30%
Electrical fast transient/burst IEC 61000-4-4	± 2kV for power supply lines + 1kV for input/output lines	+ 2kV for power supply lines + 1kV for input/output lines	Mains power quality should be that of a typical commercial or hospital environment.
Surge IEC 61000-4-5	± 1kV line(s) to line(s) ± 2kV line(s) to earth	+ 1kV line(s) to line(s) + 2kV line(s) to earth	Mains power quality should be that of a typical commercial or hospital environment.
Voltage Dips, short interruptions and voltage variations on power supply input lines IEC 61000-4-11	<u>0% UT for 0,5 cycle</u> <u>0% UT for 1 cycle</u> <u>70% UT(30% dip in UT) for 25 cycles</u> <u>0% UT for 5 s</u>	<u>0% UT for 0,5 cycle</u> <u>0% UT for 1 cycle</u> <u>70% UT(30% dip in UT) for 25 cycles</u> <u>0% UT for 5 s</u>	Mains power quality should be that of a typical commercial or hospital environment. If the user of the device requires continued operation during power mains interruptions, it is recommended that the device be powered from an uninterruptible power supply or a battery.
Power frequency(50/60 Hz) magnetic field IEC 61000-4-8	<u>30 A/m</u>	<u>30 A/m</u>	The device power frequency magnetic fields should be at levels characteristic of a typical location in a typical commercial or hospital environment.
NOTE UT is the a.c. mains voltage prior to application of the test level.			

Guidance and manufacturer's declaration-electromagnetic immunity

The MS5900 Infant Scale is intended for use in the electromagnetic environment specified below. The customer or the user of the device should assure that is used in such an environment.

Immunity test	IEC 60601 test level	Compliance level	Electromagnetic environment-guidance
<p>Conducted RF IEC 61000-4-6</p> <p>Radiated RF IEC 61000-4-3</p>	<p>3 Vrms 150 KHz to 80 MHz</p> <p><u>6 V in ISM bands between 0,15 MHz and 80 MHz</u> <u>80 % AM at 1 kHz</u></p> <p>3 V/m 80MHz to 2,7 GHz</p>	<p>3 Vrms 150 KHz to 80 MHz</p> <p><u>6 V in ISM bands between 0,15 MHz and 80 MHz</u> <u>80 % AM at 1 kHz</u></p> <p>3 V/m <u>80MHz to 2,7 GHz</u></p>	<p>Portable and mobile RF communications equipment should be used no closer to any part of the device including cables, than the recommended separation distance calculated from the equation applicable to the frequency of the transmitter.</p> <p>Recommended separation distance:</p> <p>$d = 1,2 \sqrt{P}$ $d = 1,2 \sqrt{P}$ 80MHz to 800 MHz $d = 2,3 \sqrt{P}$ 800MHz to 2,5 GHz</p> <p>Where P is the maximum output power rating of the transmitter in watts (W) according to the transmitter manufacturer and d is the recommended separation distance in metres (m).</p> <p>Field strengths from fixed RF transmitters, as determined by an electromagnetic site survey^a, should be less than the compliance level in each frequency range^b.</p> <p>Interference may occur in the vicinity of equipment marked with the following symbol:</p> <div style="text-align: center;">  </div>

NOTE1 At 80 MHz and 800 MHz, the higher frequency range applies.

NOTE2 These guidelines may not apply in all situations. Electromagnetic propagation is affected by absorption and reflection from structures, objects and people.

- a Field strengths from fixed transmitters, such as base stations for radio (cellular/cordless) telephones and land mobile radios, amateur radio, AM and FM radio broadcast and TV broadcast cannot be predicted theoretically with accuracy. To assess the electromagnetic environment due to fixed RF transmitters, an electromagnetic site survey should be considered. If the measured field strength in the location in which the device is used exceeds the applicable RF compliance level above, the device should be observed to verify normal operation. If abnormal performance is observed, additional measures may be necessary, such as re-orienting or relocating the device.
- b Over the frequency range 150 kHz to 80 MHz, field strengths should be less than 3 V/m.

Recommended separation distance between portable and mobile RF communications equipment and the MS5900 Infant Scale

The device is intended for use in an electromagnetic environment in which radiated RF disturbances are controlled. The customer or the user of the device can help prevent electromagnetic interference by maintaining a minimum distance between portable and mobile RF communications equipment (transmitters) and the device as recommended below, according to the maximum output power of the communications equipment.

Rated maximum output power of transmitter W	Separation distance according to frequency of transmitter m		
	150 kHz to 80 MHz $d = 1,2\sqrt{P}$	80 MHz to 800 MHz $d = 1,2\sqrt{P}$	800 MHz to 2,5 GHz $d = 2,3\sqrt{P}$
0,01	0,12	0,12	0,23
0,1	0,38	0,38	0,73
1	1,2	1,2	2,3
10	3,8	3,8	7,3
100	12	12	23

For transmitters rated at a maximum output power not listed above, the recommended separation distance d in metres (m) can be estimated using the equation applicable to the frequency of the transmitter, where p is the maximum output power rating of the transmitter in watts (W) according to the transmitter manufacturer.

NOTE1 At 80 MHz and 800 MHz, the separation distance for the higher frequency range applies.

NOTE2 These guidelines may not apply in all situations. Electromagnetic propagation is affected by absorption and reflection from structures, objects and people.

II. Installation

A. Height Measure Attachment

1. Remove bracket holder cover.

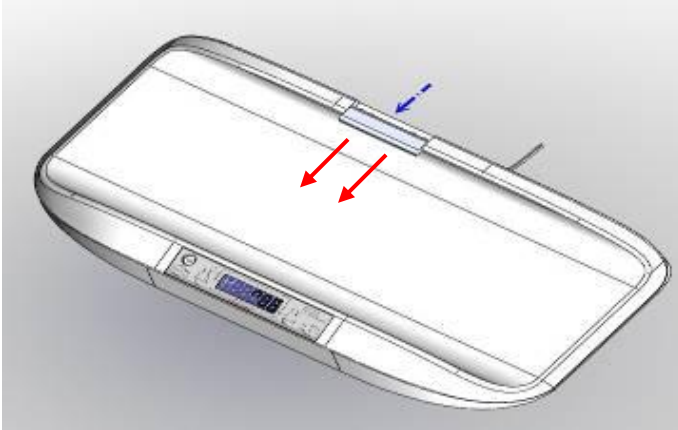

2. Attach bracket to device with two screws.

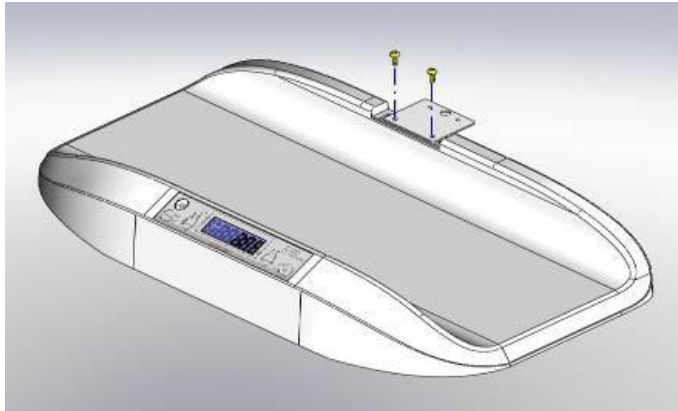

3. Attach height rod to bracket carefully until a click noise is heard.
(HM80D used as example)

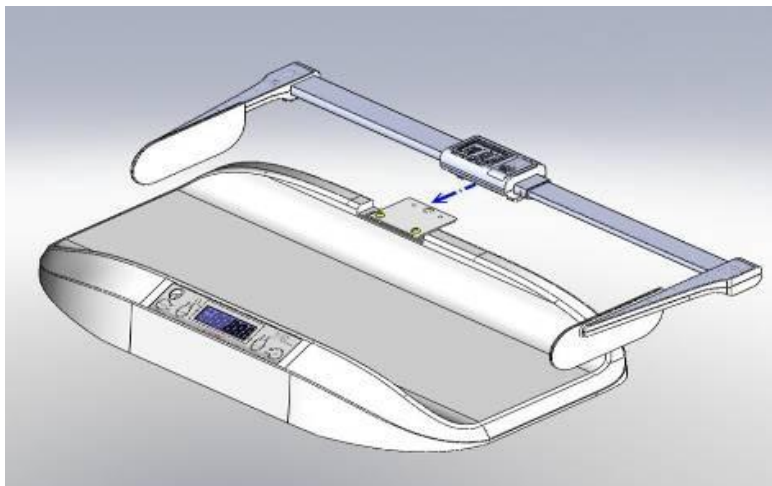

4. Install bracket holder cover.

(HM80D)

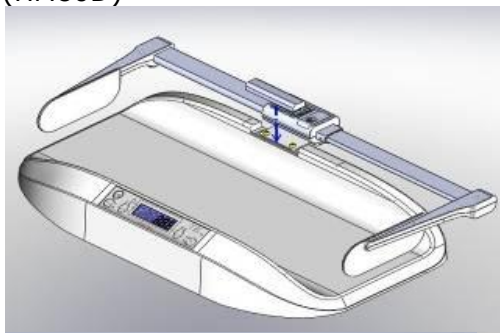

(HM80M)

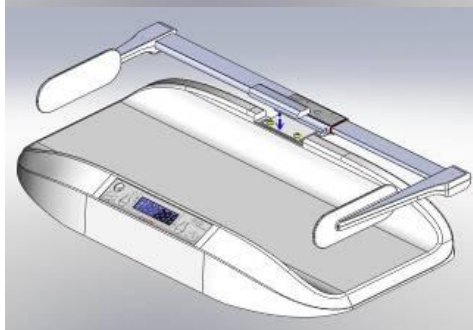

5. Disassembling height rod

Locate buckle at bottom of height rod. Press down on buckle and slid out height rod.

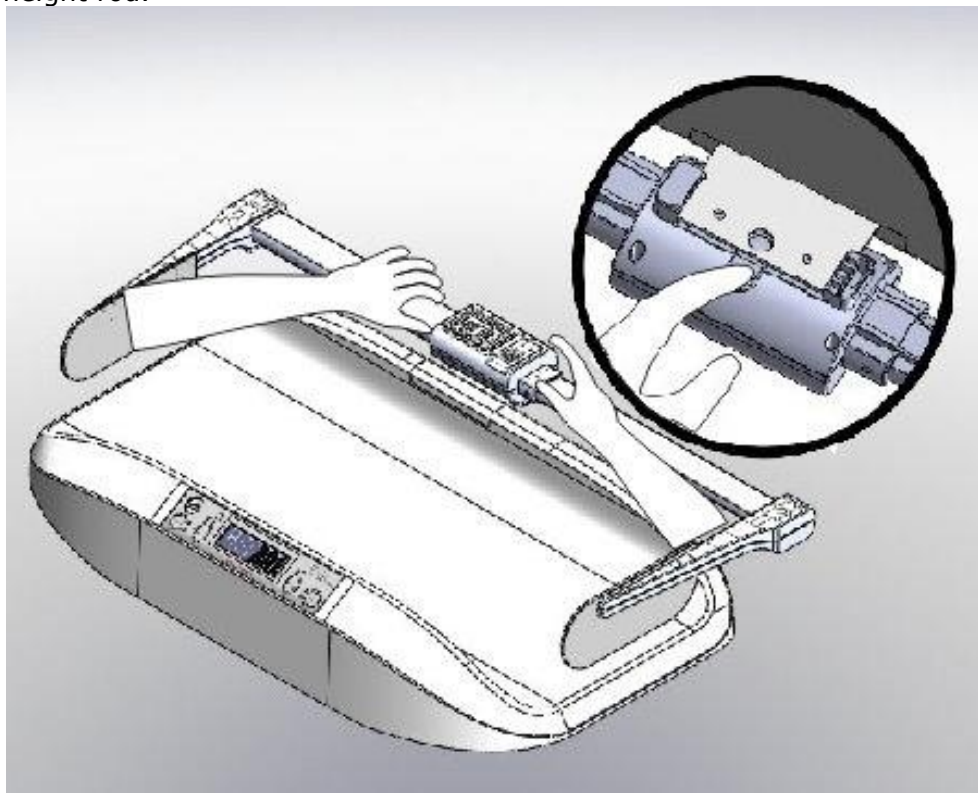

B. Inserting Batteries

Step 1. Open battery cover and take out battery compartment. Insert batteries correctly according to polarity.

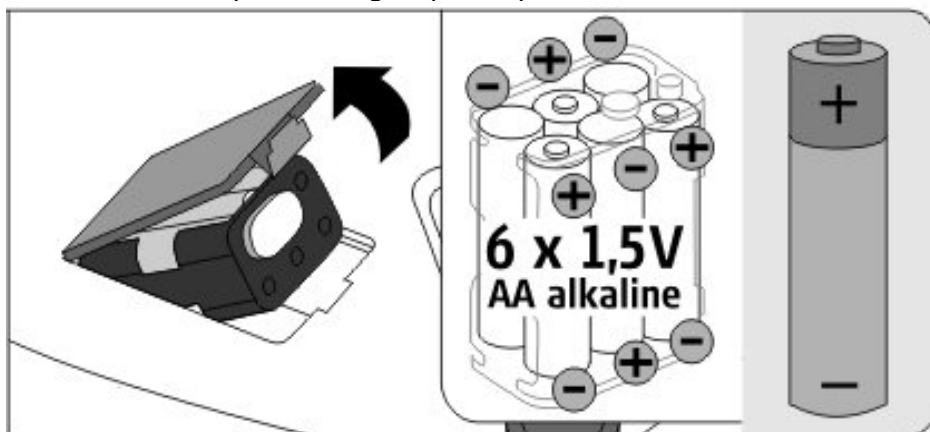

If **LoBat** prompt displays on the LCD, please replace batteries or plug in adapter.

C. Using AC Adapter

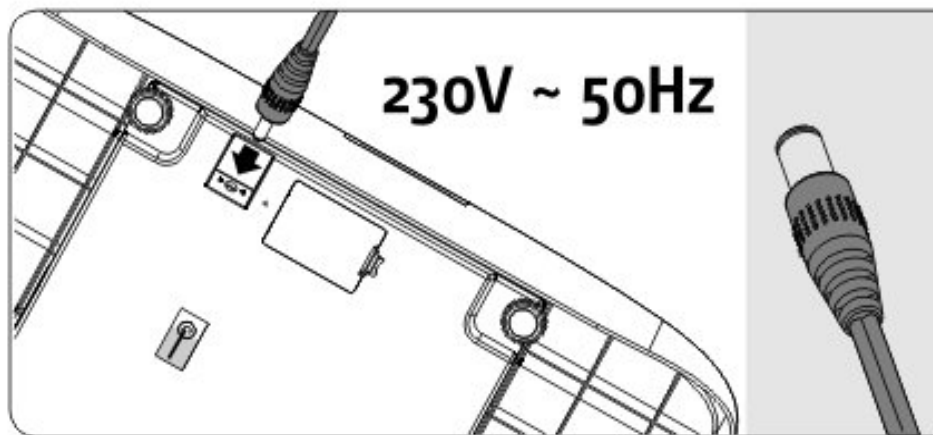

Device can be powered using AC adapter. Plug adapter into device before plugging into mains.



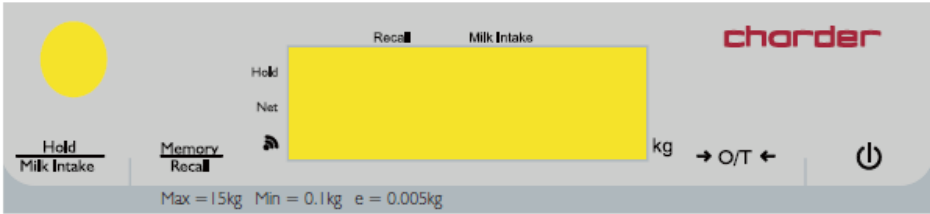

III. Indicator and Key Functions



Display

- : Stable
- : Negative weight
- : Zero

Key Function

1. **Hold/Milk Intake**:
 - Press **[Hold/Milk Intake]** key once to hold weight. To return to normal weighing mode, press **[Hold/Milk Intake]** key again.
 - Press and hold **[Hold/Milk Intake]** key for 3 seconds to enable Milk Intake function.
2. **Memory/Recall**:
 - Press **[Memory/Recall]** key to recall stored weight.
 - Press and hold **[Memory/Recall]** key for 3 seconds to store current weight.
3. **O/T** (Zero/Tare):
 - Press **[O/T]** key to zero scale ($\pm 2\%$ of full capacity).
 - Press **[O/T]** key to tare weight on device.
4.  (On/Off):
 - Press  to turn device on or off.

IV. Using Device

A. Basic Operation

Switch on the device using  key. The device will automatically perform self-calibration, displaying software version.

Once "0.00 kg" appears on indicator, device is ready for measurement.

Note: If "0.00 kg" does not display on indicator, press [**ZERO**] key to zero the device. This function can be used for weight within $\pm 2\%$ of full capacity.

Gently place baby on tray. Press [**Hold/Milk Intake**] key. HOLD symbol will appear on indicator. After weight has stabilized, the HOLD symbol will disappear, displaying baby's weight on indicator.

Note: If baby's weight exceeds device capacity (including tare), indicator will display "Err" prompt due to overload.

Press [**Hold/Milk Intake**] to disable Hold function.

Note: Hold function can be activated before or after baby is placed on tray. However, if baby cannot hold still, we recommend activating Hold after placing baby on tray.



B. Recall



1. After baby weight has been measured, press and hold [**Memory/Recall**] key for 3 seconds to store weight.
2. Press [**Memory/Recall**] key to recall stored weight.

C. Milk Intake

The milk intake function makes it easy to record baby's milk intake. Begin by measuring baby weight before milk intake.

1. Weigh baby before feeding.

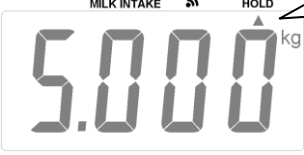

	Display
	MILK INTAKE  HOLD
Turn on device.	

Place baby on tray (5kg used as an example)	
Press Hold/Milk Intake key	
Press and hold Memory/Recall key for 3 seconds to store baby weight.	
Baby can be removed from tray for feeding. Indicator will return to normal mode. (0.00kg)	

Triangle will appear next to "HOLD"

Display flashes three times and stores baby weight

2. Feed baby.
3. Weigh baby after feeding.

Turn on device.	<p style="text-align: center;">Display</p> 
Place baby on tray (5.2kg weight after feeding used as example)	
Press and hold Hold/Milk Intake key for 3 seconds. Milk Intake will be displayed on screen (0.2kg in example)	

Triangle will appear next to "MILK INTAKE"

Press

Hold/Milk Intake

key to return to
normal mode.



D. Printing

If thermal printer is connected to indicator via transfer cable, results can be printed.



VII. Wireless Connection

If the device has the wireless module installed, the indicator can transmit measurement results wirelessly.

A. Turning on Wi-Fi

1. Turn on the scale. Press and hold **[O/T]** key for 3 seconds to enter settings.

2. Press **[Hold/Milk Intake]** key several times until **WiFi** appears to see status (ON/OFF). If status is OFF, press **[O/T]** key to enter, press **[Hold/Milk Intake]** key to switch to ON, and press **[O/T]** key to confirm settings.

3. Press **[Hold/Milk Intake]** key several times until **End** appears, and press **[O/T]** key to save and return to normal mode.



*** No triangular sign: Wireless power from scale is off ***

*** Triangular sign shows up continuously: connecting...***

*** Triangular sign is blinking: connected ***

B. Connecting device wirelessly

Download appropriate software from PC to tablet.



Ensure tablet wireless is turned on, and connect to internet.

1. Open software on tablet

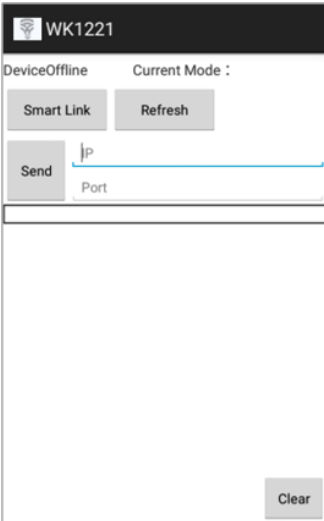

3. Enter password in the red column, and press **Next**. (no need to enter data in blue column)

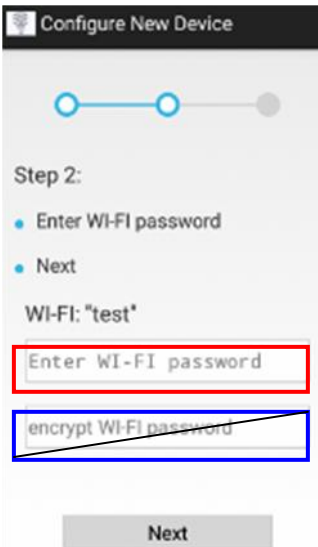

2. Press **Smart Link**, and press **Next**.

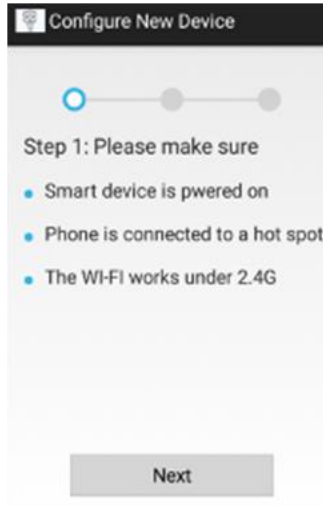

4. Press the **Press to Start** button.



5. After configuration, it shows Device is connecting



6. After a few seconds, screen will display the following:

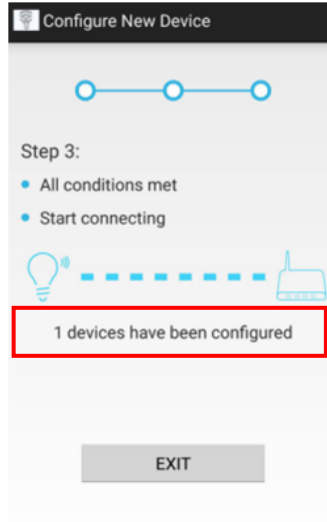

7. Press **EXIT** to return to main menu

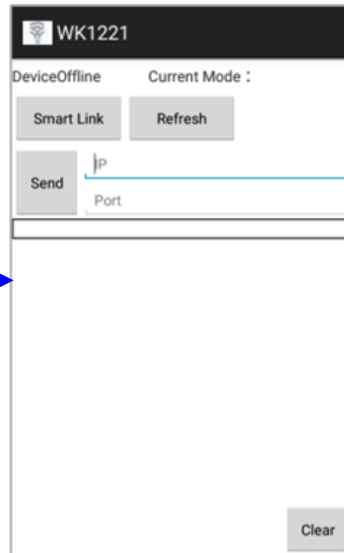
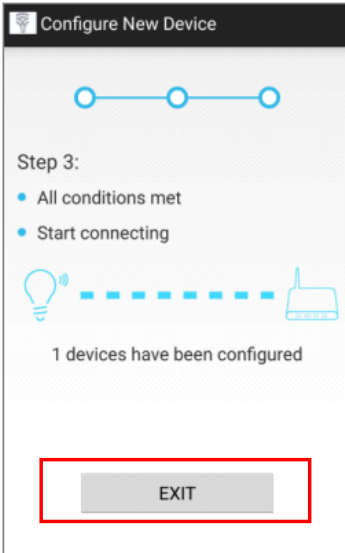

8. Press Refresh. Program will display:

« Device : Online Current Mode: STATION_MODE »

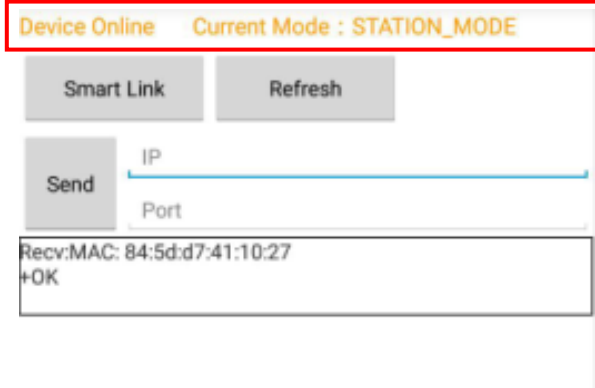

9. Enter IP and Port, and then press **Send**.

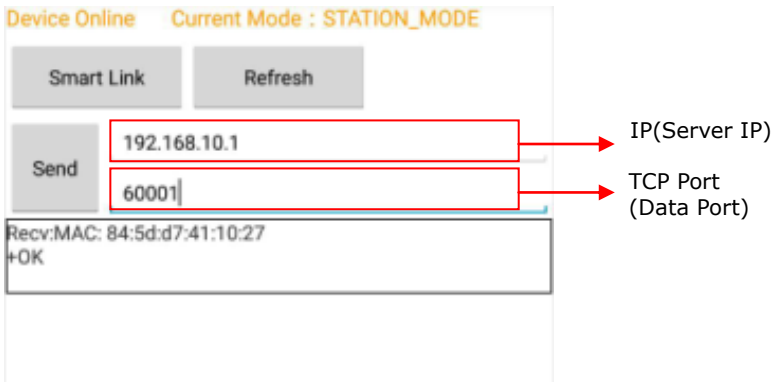

10. Turn off scale, and turn it back on (Wireless setting completed).

NOTE: If connection fails, please follow the instruction to conduct "factory reset":

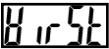
1. Turn on the device, press and hold **[O/T]** key for 6 seconds to enter setup.
2. Press **[Hold/Milk Intake]** key several times until LCD shows 
3. Press **[O/T]** key to enter settings. If LCD shows NO, press **[Hold/Milk Intake]** key to switch to YES.
4. When LCD shows YES, press **[O/T]** key once until you see "rSt", and then "OK".
5. Press **[Hold/Milk Intake]** key until LCD shows "End". Press **[O/T]** key to return to normal mode and complete factory reset.

VI. Device Setup

When the device is switched on, press and hold the **[O/T]** key until the display shows the "SETUP", followed by "A_OFF" (first option in setting menu).

In device setup:

[Hold/Milk Intake] to toggle menu option

[O/T] to confirm selection / enter submenu



Auto Power-Off: Instruct device to shut off automatically after a certain period of time.

Auto off options: 60 sec / 120 sec / 240 sec / 300 sec / off

Press **[Hold/Milk Intake]** key to select target time. After selection, press **[O/T]**. Indicator will return to "A.OFF".



Set device date: Format/order is YYYY/MM/DD/HH:MM. (24-hour)



Year Month.Day Hour.Minute

[Hold/Milk Intake] : select next digit

[O/T]: increase



: Enter / confirm input

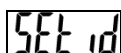

Set scale ID: this function is used by service technician, and user normally does not need to change setting.

Press **[Hold/Milk Intake]** to toggle between no/yes, and **[O/T]** to confirm selection.



Bluetooth (optional): If device has Bluetooth module installed, Bluetooth function can be turned on or off.

Press **[Hold/Milk Intake]** to toggle between on/off, and **[O/T]** to confirm selection.



Wi-Fi (optional): If device has Wi-Fi module installed, Wi-Fi function can be turned on or off.

Press **[Hold/Milk Intake]** to toggle between on/off, and **[O/T]** to confirm selection.



Test Wi-Fi connection issue (optional): If device has Wi-Fi module installed, this function is to be used by service technician, and user normally does not need to change setting.

Press **[Hold/Milk Intake]** to toggle between no/yes, and **[O/T]** to confirm selection.

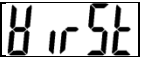

Wi-Fi App Setting (optional): If device has Wi-Fi module installed, this function is to be used by service technician, and user normally does not need to change setting.

Press **[Hold/Milk Intake]** to toggle between no/yes, and **[O/T]** to confirm selection.

After completing settings, press **[Hold/Milk Intake]** key. "End" will display. Press **[O/T]** key to apply changes and end settings.

VII. Troubleshooting

Before contacting your local Charder distributor for repair service, we recommend considering the following troubleshooting procedures:

Self-inspection

1. Device will not power on

- If battery power is depleted, replace with new batteries
- If batteries are not used, check if the power adapter is plugged into the device properly. Check if power adapter is plugged into mains properly

2. Indicator showing "0000" ZERO SPAN out of range

- Interference due to factors such as RF disturbance or ground vibration. Relocate device to location without interference and try again
- Unstable platform. Relocate device to stable location and try again
- External objects interfering with measurement platform. Clear platform of objects and try again
- Device may not function properly on soft surfaces such as carpets or lawns. Relocate device to location with solid, stable floor
- If the steps above cannot resolve the problem, re-calibration may be required to correct weighing accuracy

Distributor support required

If the following errors occur, we recommend contacting your local Charder distributor for repair or replacement services:





1. Device will not power on

- Faulty on/off key
- Broken or damaged wires causing short circuit or faulty connection
- Safety fuse burnout
- Faulty adapter

2. Indicator damage

- Possible hardware defects include: uneven brightness in LCD screen, blurred text, smeared rainbow screen, incorrect decimal display
- Unable to save or read data
- Indicator shows "ERRL" after device is switched on
- Keys not responding
- Buzzer malfunction

Error Messages

Error Message	Reason	Action
	Low battery warning Voltage of battery is too low to operate device	Replace batteries, or plug in adapter
	Overload Total load exceeds device's maximum capacity	Reduce weight on measurement platform and try again
	Zero count over calibration zero range +10% while power on	Re-calibration required. Please contact distributor
	Zero count under calibration zero range -10% while power on	Re-calibration required. Please contact distributor
	Program Error Fault with device software	Error normally caused by faulty loadcell or wiring. Please contact distributor

VIII. Product Specifications

Model		MS5900	
Weight Measurement	Capacity	(15 kg model) 0-6 kg x 2g 6-15 kg x 5g	(20 kg model) 0-10 kg x 5g 10-20 kg x 10g
	Accuracy	±1.5e	
	OIML	Class III	
	LCD Screen	1.0-inch LCD screen (5 digits)	
Dimensions	Overall	670(W) x 330(D) x 125(H) mm	
	Tray	630(W) x 250(D) x 70(H) mm	
Device Weight		4.1 kg	
Key Functions		On/Off, Zero/Tare, Memory/Recall, Hold/Milk Intake	
Data Transmission		USB, Wireless Module (optional) NOTE: Device should be connected to network by qualified distributors only	
Power Supply		6 AA batteries / Power adapter	
Operation Temperature & Humidity		0°C~40°C 15% / 85% RH	
Standard Accessories		User manual x1 Power Adapter x1	
Optional Accessories		Height Rod, Thermal Printer Carrying bag	



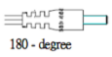

Warning

The device is only compatible with the power adapters specified below.

AMP VOLTAGE	DRAWING NO.	CE APPROVED TYPE NO. / MODEL NO.	TYPE	Adapter plug
12V 1A	AD-8096	UE24WCP1-120100SPA	US	 180-degree
			EU	
			UK	
			AU	

IX. Declaration of Conformity

This product has been manufactured in accordance with the harmonized European standards, following the provisions of the below stated directives:

	93/42/EEC as amended by 2007/47/EC Medical Device Directive
	2014/31/EU Non-automatic Weighing Instruments Directive

Please see separate document showing on sticker of device for above CE marking.

Authorized EU Representative:



Obelis s.a.

Bd Général Wahis, 53
B-1030 Brussels
Belgium



Manufactured by:
Charder Electronic Co., Ltd.
No.103, Guozhong Rd., Dali Dist.,
Taichung City, 41262 Taiwan (R.O.C.)

CD-IN-00120 REV 005 04/2021