

















USER MANUAL
MS5440
Chair Scale



Please keep the instruction manual at hand all the time for future reference.

Explanation of Graphic Symbols on Label/Packaging

	Caution, consult accompanying documents before use		Separate collection for waste of electrical and electronic equipment, in accordance with Directive 2002/96/EC
	Manufacturer of medical device		Manufacturing year of medical device
	Carefully read user manual before installation and usage, and follow instructions for use.		Medical electrical equipment with Type B applied part
	Device catalogue number		Authorized representative in the European Community
	Manufacturer's batch or lot number		Device is a medical device
	Serial number		Unique Device Identifier
		Device conforms to 93/42/EEC as amended by 2007/47/EC Medical Device Directive. Four digit number refers to Notified Body.	
		Device complies with International Organization of Legal Metrology (Class III) requirements (verified models only)	
		Device complies with EC directives (verified models only) M : Conformity label in compliance with Directive 2014/31/EU for non-automatic weighing instruments 18 : Year in which conformity verification was performed and the CE label was applied. (ex: 18=2018) 0122 : Refers to Notified Body for metrology	

Copyright Notice
Charder Electronic Co., Ltd.

No.103, Guozhong Rd., Dali Dist., Taichung City 41262 Taiwan

Tel: +886-4-2406 3766

Fax: +886-4-2406 5612

Website: www.chardermedical.com E-mail: info_cec@charder.com.tw

Copyright© Charder Electronic Co., Ltd. All rights reserved.
This user manual is protected by international copyright law. All content is licensed, and usage is subject to written authorization from Charder Electronic Co., Ltd. (hereinafter Charder) Charder is not liable for any damage caused by a failure to adhere to requirements stated in this manual. Charder reserves the right to correct misprints in the manual without prior notice, and modify the exterior of the device for quality purposes without customer consent.



Charder Electronic Co., Ltd.
No. 103, Guozhong Rd., Dali Dist.,
Taichung City, 41262 Taiwan

CONTENTS

I. Safety Notes	5
A. General Information	5
B. EMC Guidance and Manufacturer's Declaration	8
II. Installation	12
A. Unpacking	12
B. Assembling/Adjusting Device	13
C. Inserting Batteries	23
D. Using Adapter	26
III. Indicator	27
A. Indicator and Key Functions	27
B. Display layout	28
IV. Using Device	29
A. Basic Operation	29
B. Hold	29
C. BMI	29
D. Tare	30
E. Pre-Tare	30
F. Print	34
V. Device Setup	35
A. Setting Time & Date	35
B. Device Setup	36
VI. Setup USB Connection to PC	38
VII. Wireless Connection	41
VIII. Troubleshooting	42
IX. Product Specifications	44
X. Declaration of Conformity	48



I. Safety Notes

A. General Information

Thank you for choosing this Charder Medical device. It is designed to be easy and straightforward to operate, but if you encounter any problems not addressed in this manual, please contact your local Charder service partner.

Before beginning operation of the device, please read this user manual carefully, and keep it in a safe place for reference. It contains important instructions regarding installation, proper usage, and maintenance.

Intended Use

This device is intended to measure the weight of subjects with limited mobility, for diagnosis of weight-related issues by professionals.

General Handling

- Device should be placed on stable, flat, solid, non-slippery surface.
- Usage on soft surfaces (ex: carpet) may result in inaccurate results.
- Ensure all parts are properly locked and tightened before operating the device.
- Device is intended to measure one subject at a time.

Safety Instructions

- Batteries should be kept away from children. If swallowed, promptly seek medical assistance.
- Expected service life: 5 years.
- Always comply with appropriate regulations when using electrical components under increased safety requirements.
- Ensure voltage marked on power supply matches mains power supply.
- The device is intended for indoor use only.
- Observe permissible ambient temperatures for use

Environmental

- All batteries contain toxic compounds; batteries should be disposed of via designated competent organizations. Batteries should not be incinerated.

Cleaning

- Device surface should be cleaned using alcohol-based wipes. Corrosive cleansing liquids should not be used. Pressure-washers should not be used.

- Do not use large amounts of water when cleaning the device, as it may cause damage to the internal electronics.
- Always disconnect device from mains power before cleaning.

Maintenance

- Device does not require routine maintenance. However, regular checking of accuracy is recommended; frequency to be determined by level of use and state of device. If results are inaccurate, please contact local distributor.

Warranty/Liability

- The period of warranty shall be eighteen (18) months, beginning on the date of purchase. Please retain your receipt as proof of purchase.
- No responsibility shall be accepted for damage caused through any of the following reasons: unsuitable or improper storage or use, incorrect installation or commissioning by the owner or third parties, natural wear and tear, changes or modifications, incorrect or negligent handling, chemical, electrochemical, or electrical interference.
- All maintenance, technical inspections, and repairs should be conducted by an authorized Charder service partner, using original Charder accessories and spare parts. Charder is not liable for any damages arising from improper maintenance or usage.

Disposal

- This product is not to be treated as regular household waste, but should be taken to a designated collection points for electronics. Further information should be provided by local waste disposal authorities.



Warning

- Only the original adapter should be used with the device. Using an adapter other than the one provided by Charder may cause malfunction.
- Do not touch the power supply with wet hands.
- Do not crimp the power cable, and avoid sharp edges.
- Do not overload extension cables connected to the device.
- Route cables carefully, to avoid tripping.
- Keep device away from liquids.
- Do not remove the plug by yanking on the cable.
- Use only a correctly wired (100-240VAC) outlet, and do not use a multiple outlet extension cable.

- Do not under any circumstances dismantle or alter the device, as this could result in electric shock or injury as well as adversely affect the precision of measurements.
- Do not place the device in direct sunlight, or in close proximity to an intense heat source. Excessively high temperatures may damage the internal electronics.



Warning

Measurements for physically disabled persons.

- Physically disabled persons should not attempt to take measurements alone, but instead should have their caretakers assist them in using the device.
- Footrest can only be used when subject is sitting in chair. To avoid injury, subject should refrain from standing on footrest, as device may tip over if used incorrectly.



Incident Reporting

Any serious incident that has occurred in relation to the device should be reported to the manufacturer, EU representative (if device is used in EU member state), and competent authority of user/subject's member state.

B. EMC Guidance and Manufacturer's Declaration

Guidance and manufacturer's declaration-electromagnetic emissions		
<p>The MS5440 Chair Scale is intended for use in the electromagnetic environment specified below. The customer or the user of the device should assure that it is used in such an environment.</p>		
Emission test	Compliance	Electromagnetic environment-guidance
RF emissions CISPR 11	Group 1	The device uses RF energy only for its internal function. Therefore, its RF emissions are very low and are not likely to cause any interference in nearby electronic equipment.
RF emissions CISPR 11	Class B	The device is suitable for use in all establishments, including domestic establishments and those directly connected to the public low-voltage power supply network that supplies buildings used for domestic purposes.
Harmonic emissions IEC 61000-3-2	Class A	
Voltage fluctuations /flicker emissions IEC 61000-3-3	Compliance	

Guidance and manufacturer's declaration-electromagnetic immunity

The MS5440 Chair Scale is intended for use in the electromagnetic environment specified below. The customer or the user of the device should assure that it is used in such an environment.

Immunity test	IEC 60601 test level	Compliance level	Electromagnetic environment-guidance
Electrostatic discharge(ESD) IEC 61000-4-2	<u>± 8 kV contact</u> <u>± 2 kV, ± 4 kV,</u> <u>± 8 kV, ± 15 kV</u> <u>air</u>	<u>± 8 kV contact</u> <u>± 2 kV, ± 4 kV,</u> <u>± 8 kV, ± 15 kV</u> <u>air</u>	Floors should be wood, concrete or ceramic tile. If floors are covered with synthetic material, the relative humidity should be at least 30%
Electrical fast transient/burst IEC 61000-4-4	± 2kV for power supply lines + 1kV for input/output lines	+ 2kV for power supply lines + 1kV for input/output lines	Mains power quality should be that of a typical commercial or hospital environment.
Surge IEC 61000-4-5	± 1kV line(s) to line(s) ± 2kV line(s) to earth	+ 1kV line(s) to line(s) + 2kV line(s) to earth	Mains power quality should be that of a typical commercial or hospital environment.
Voltage Dips, short interruptions and voltage variations on power supply input lines IEC 61000-4-11	<u>0% UT for 0,5 cycle</u> <u>0% UT for 1 cycle</u> <u>70% UT(30% dip in UT) for 25 cycles</u> <u>0% UT for 5 s</u>	<u>0% UT for 0,5 cycle</u> <u>0% UT for 1 cycle</u> <u>70% UT(30% dip in UT) for 25 cycles</u> <u>0% UT for 5 s</u>	Mains power quality should be that of a typical commercial or hospital environment. If the user of the device requires continued operation during power mains interruptions, it is recommended that the device be powered from an uninterruptible power supply or a battery.
Power frequency(50/60 Hz) magnetic field IEC 61000-4-8	<u>30 A/m</u>	<u>30 A/m</u>	The device power frequency magnetic fields should be at levels characteristic of a typical location in a typical commercial or hospital environment.
NOTE UT is the a.c. mains voltage prior to application of the test level.			

Guidance and manufacturer's declaration-electromagnetic immunity

The MS5440 Chair Scale is intended for use in the electromagnetic environment specified below. The customer or the user of the device should assure that is used in such an environment.

Immunity test	IEC 60601 test level	Compliance level	Electromagnetic environment-guidance
<p>Conducted RF IEC 61000-4-6</p> <p>Radiated RF IEC 61000-4-3</p>	<p>3 Vrms 150 KHz to 80 MHz</p> <p><u>6 V in ISM bands between 0,15 MHz and 80 MHz</u> <u>80 % AM at 1 kHz</u></p> <p>3 V/m 80MHz to 2,7 GHz</p>	<p>3 Vrms 150 KHz to 80 MHz</p> <p><u>6 V in ISM bands between 0,15 MHz and 80 MHz</u> <u>80 % AM at 1 kHz</u></p> <p>3 V/m <u>80MHz to 2,7 GHz</u></p>	<p>Portable and mobile RF communications equipment should be used no closer to any part of the device including cables, than the recommended separation distance calculated from the equation applicable to the frequency of the transmitter.</p> <p>Recommended separation distance:</p> <p>$d = 1,2 \sqrt{P}$</p> <p>$d = 1,2 \sqrt{P}$ 80MHz to 800 MHz</p> <p>$d = 2,3 \sqrt{P}$ 800MHz to 2,5 GHz</p> <p>Where P is the maximum output power rating of the transmitter in watts (W) according to the transmitter manufacturer and d is the recommended separation distance in metres (m).</p> <p>Field strengths from fixed RF transmitters, as determined by an electromagnetic site survey^a, should be less than the compliance level in each frequency range^b.</p> <p>Interference may occur in the vicinity of equipment marked with the following symbol:</p> <div style="text-align: center;">  </div>

NOTE1 At 80 MHz and 800 MHz, the higher frequency range applies.

NOTE2 These guidelines may not apply in all situations. Electromagnetic propagation is affected by absorption and reflection from structures, objects and people.

- a Field strengths from fixed transmitters, such as base stations for radio (cellular/cordless) telephones and land mobile radios, amateur radio, AM and FM radio broadcast and TV broadcast cannot be predicted theoretically with accuracy. To assess the electromagnetic environment due to fixed RF transmitters, an electromagnetic site survey should be considered. If the measured field strength in the location in which the device is used exceeds the applicable RF compliance level above, the device should be observed to verify normal operation. If abnormal performance is observed, additional measures may be necessary, such as re-orienting or relocating the device.
- b Over the frequency range 150 kHz to 80 MHz, field strengths should be less than 3 V/m.

Recommended separation distance between portable and mobile RF communications equipment and the MS5440 Chair Scale

The device is intended for use in an electromagnetic environment in which radiated RF disturbances are controlled. The customer or the user of the device can help prevent electromagnetic interference by maintaining a minimum distance between portable and mobile RF communications equipment (transmitters) and the device as recommended below, according to the maximum output power of the communications equipment.

Rated maximum output power of transmitter W	Separation distance according to frequency of transmitter m		
	150 kHz to 80 MHz $d = 1,2\sqrt{P}$	80 MHz to 800 MHz $d = 1,2\sqrt{P}$	800 MHz to 2,5 GHz $d = 2,3\sqrt{P}$
0,01	0,12	0,12	0,23
0,1	0,38	0,38	0,73
1	1,2	1,2	2,3
10	3,8	3,8	7,3
100	12	12	23

For transmitters rated at a maximum output power not listed above, the recommended separation distance d in metres (m) can be estimated using the equation applicable to the frequency of the transmitter, where p is the maximum output power rating of the transmitter in watts (W) according to the transmitter manufacturer.

NOTE1 At 80 MHz and 800 MHz, the separation distance for the higher frequency range applies.

NOTE2 These guidelines may not apply in all situations. Electromagnetic propagation is affected by absorption and reflection from structures, objects and people.

II. Installation

A. Unpacking

Remove top cover from shipping box

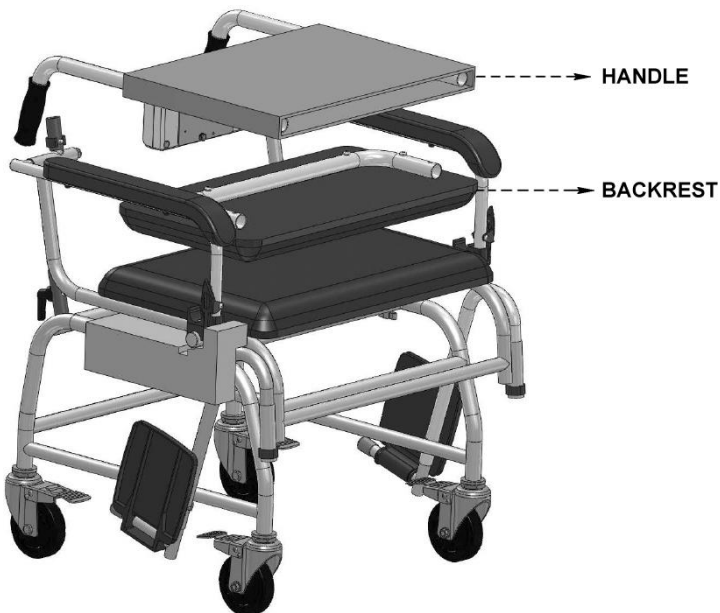
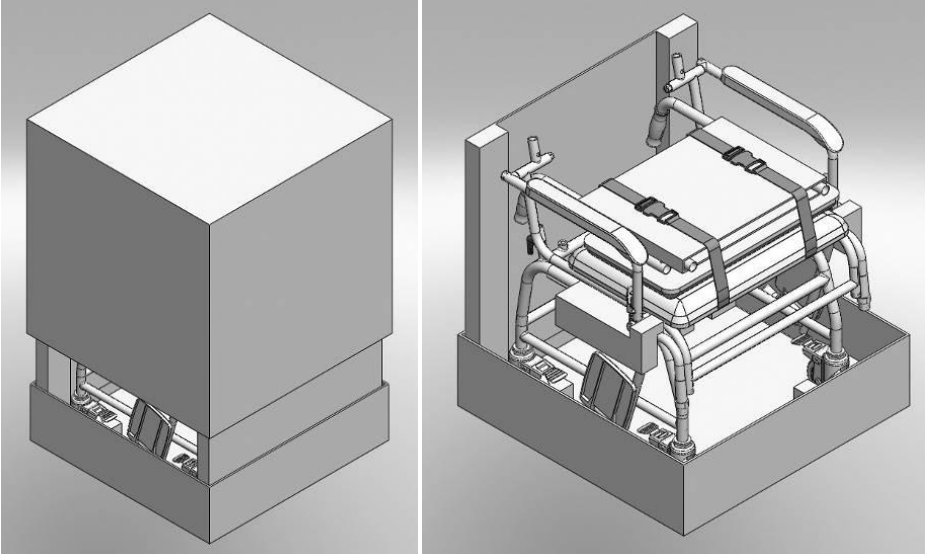

B. Assembling/Adjusting Device

Attach Backrest

1. Remove E-type clip from backrest bar

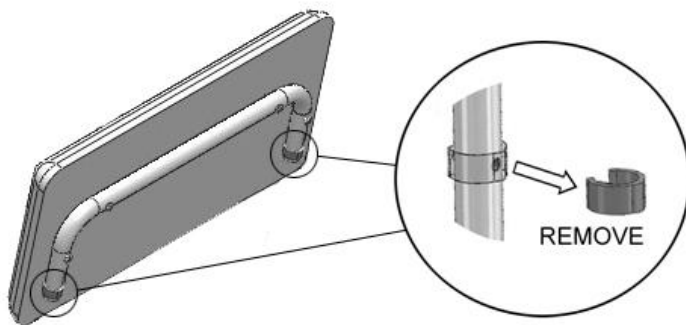

2. Insert backrest bar into device frame



3. Insert E-type clips into hole to secure backrest

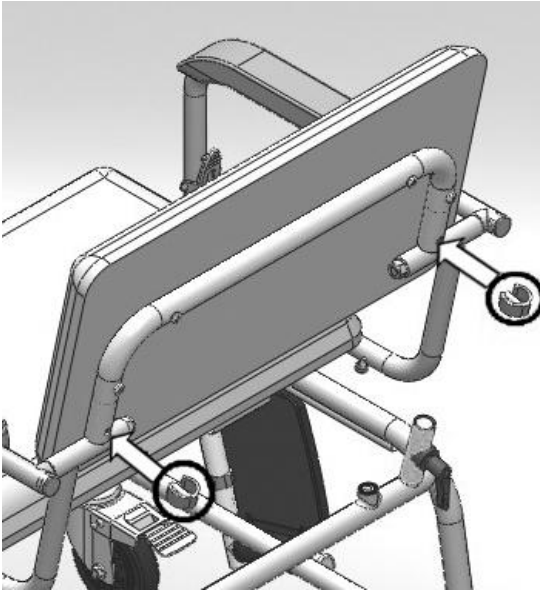

Attach Handle

1. Remove L-handle screws from device frame (turn counter-clockwise to loosen)

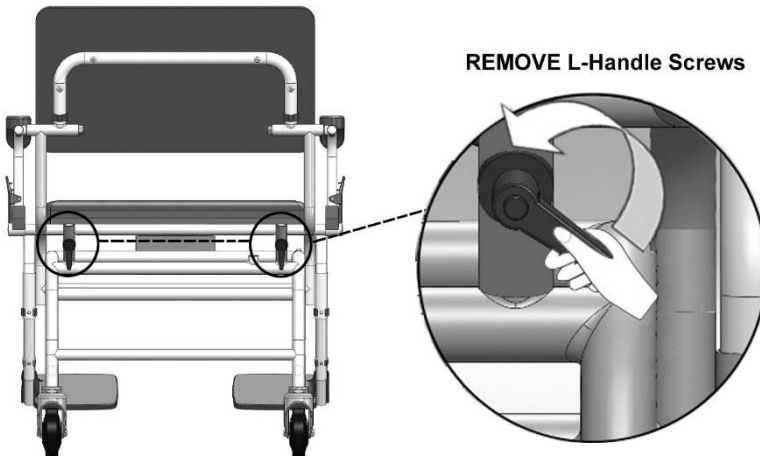

2. Insert handle frame into device frame



3. Fasten L-handle screws, securing handle frame with device frame (turn clockwise to tighten)

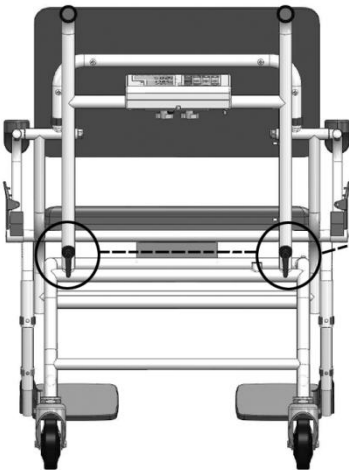

FASTEN L-Handle Screws

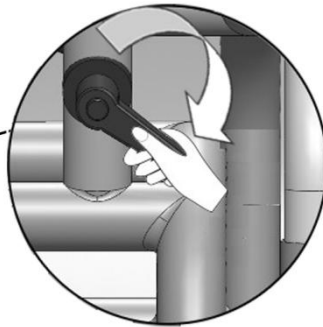

Rotate Footrest to Front

1. Raise footrest (do not remove entirely from frame)

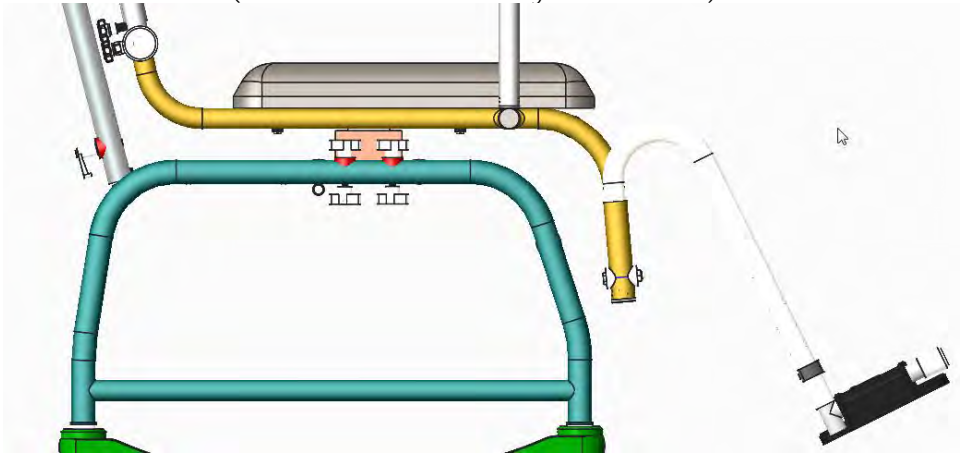

2. Rotate to front



3. Press footrest down until footrest is steady

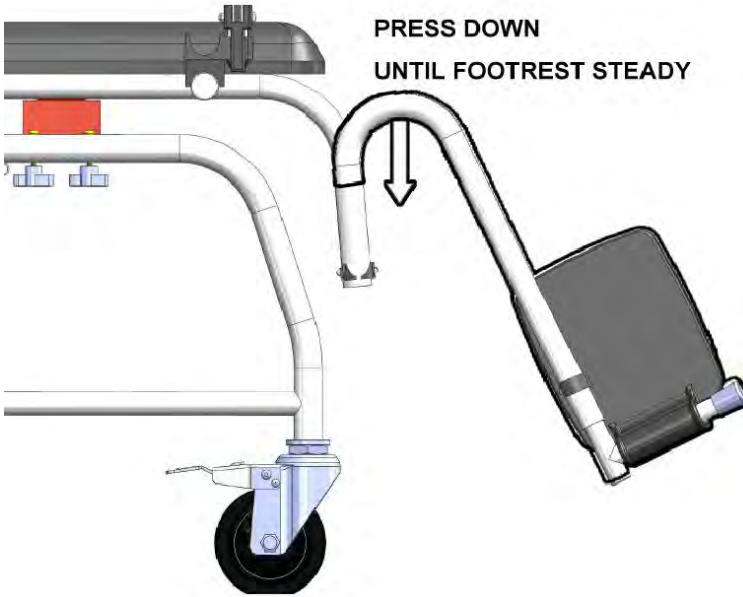

Adjust Footrest Length

1. Remove E-type clip from footrest



2. Adjust footrest height as needed

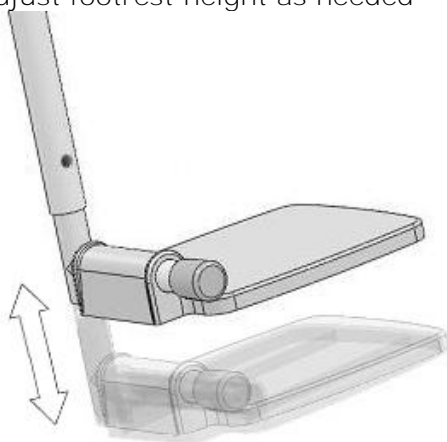

3. Insert E-type clip into footrest bar and tighten screw to secure footrest



Adjust Wheel Height

1. Place device on flat surface, apply wheel brakes



Brakes

2. To tighten wheel castor, loosen counternut slightly. After loosening, turn wheel frame clockwise to tighten.



Counternut

Wheel frame

3. Adjust wheel height until air bubble on level indicator is level



NOTE: Be careful not to lose wheels during adjustment

Raise Armrests

1. Locate knob switch for armrest



2. Pull knob switch to allow armrest to move freely

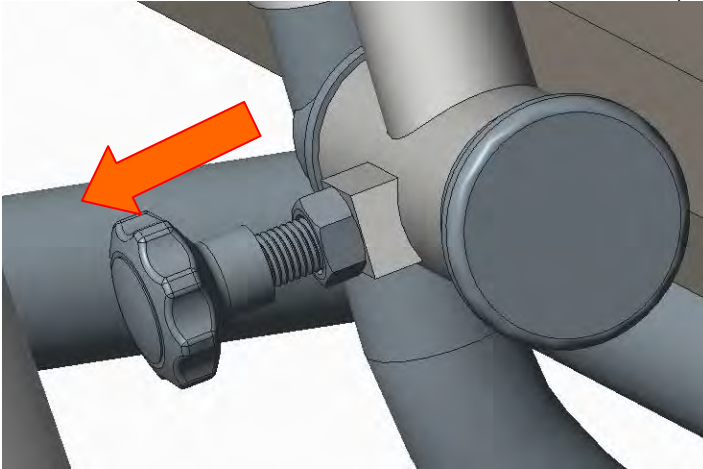

3. Armrest is now free to release



Relocate Indicator

1. Release cable from cable clips. Remove screws securing indicator to frame from device.

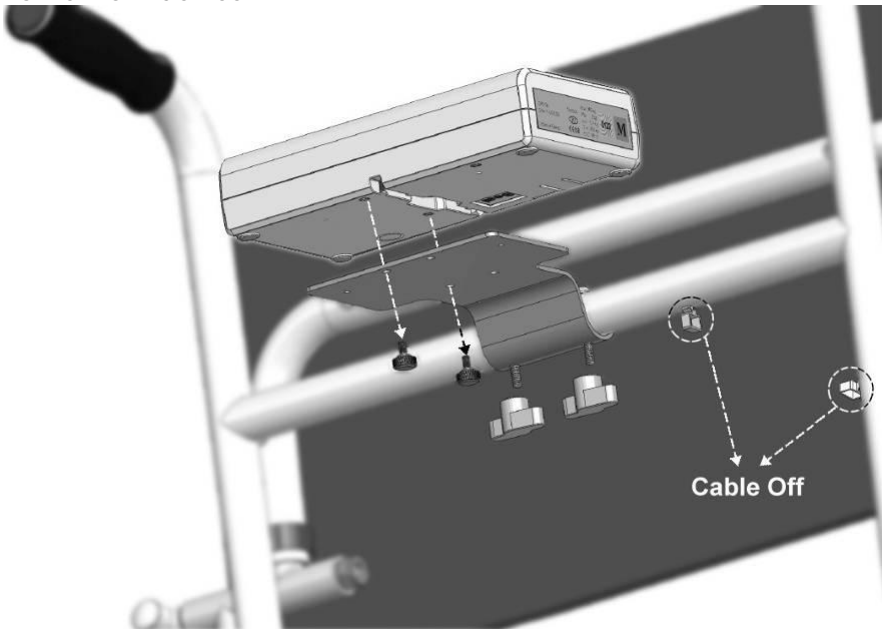

2. Relocate indicator



3. Secure cables in cable clips. Tighten screws securing indicator to device frame.

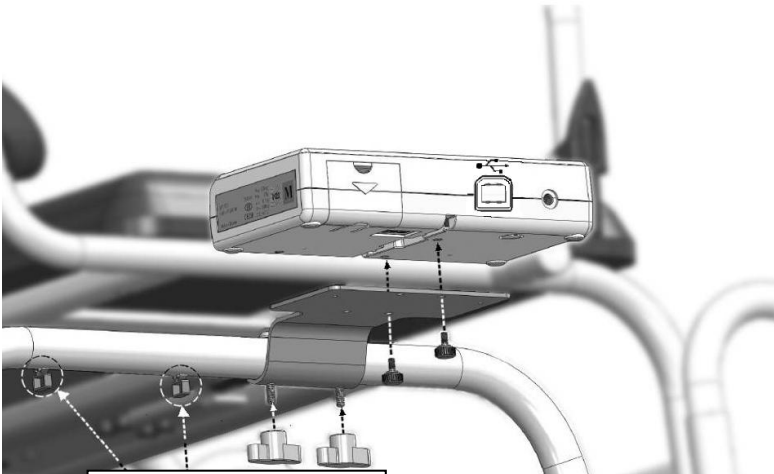

Secure cables using cable clips

C. Inserting Batteries

1. Open battery housing cover

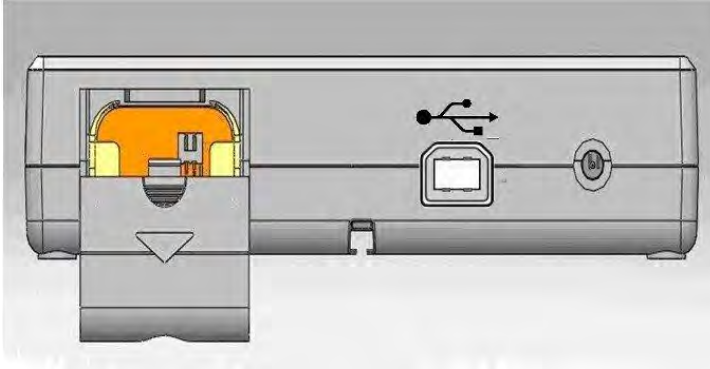

2. Accessing batteries

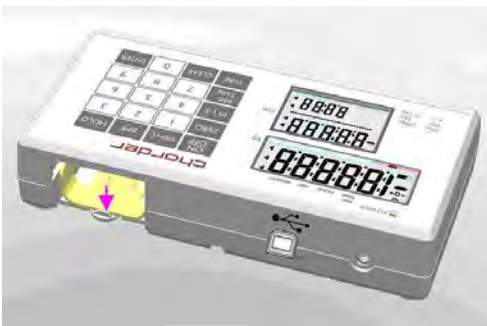

3. Use either rechargeable battery pack, or AA batteries

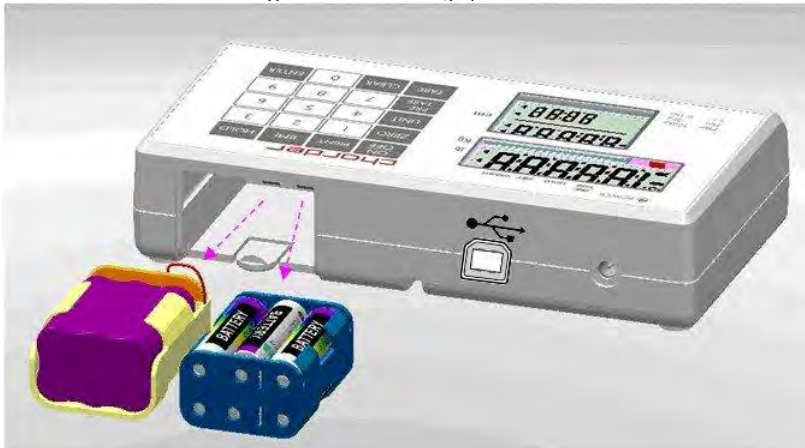

4. Ensure batteries are installed into the housing correctly

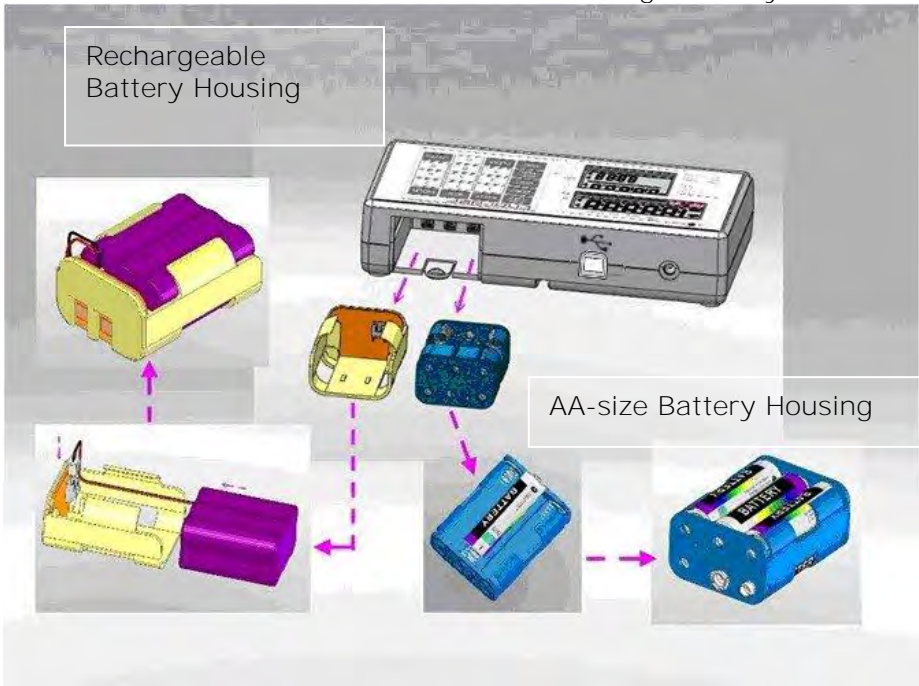

5. Install the battery housing into the compartment, and make sure the right side of housing pin is facing towards inside of the connecting position

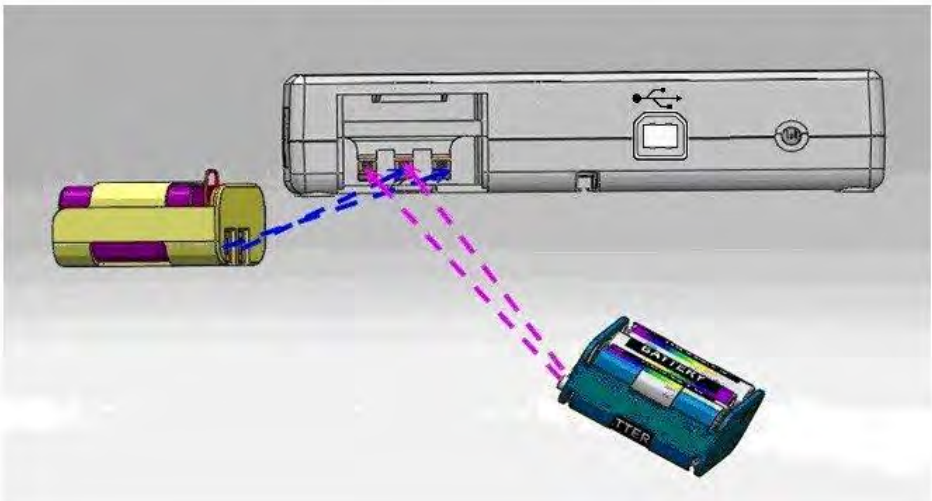

6. Slide back the cover to close the battery housing compartment. Turn on power to confirm that battery is correctly installed.

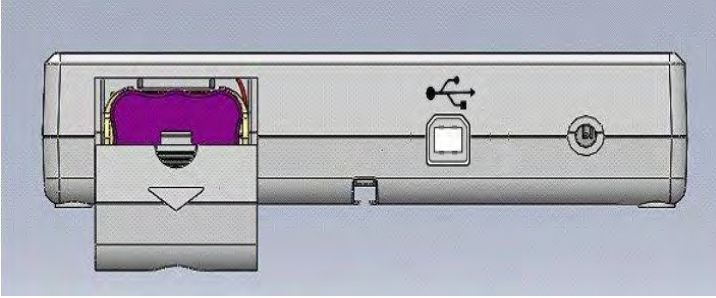

Using Rechargeable Battery (optional)

The rechargeable battery should be recharged at least once every 3 months, regardless of if the device has been used. Battery can be charged by plugging device's exclusive adapter into AC Connector Port.

After a long period in storage (e.g. >3 months), the battery should run a full cycle (charge/discharge) to allow it to restore full capacity.

Ensure rechargeable battery housing is installed and inserted properly into the compartment.

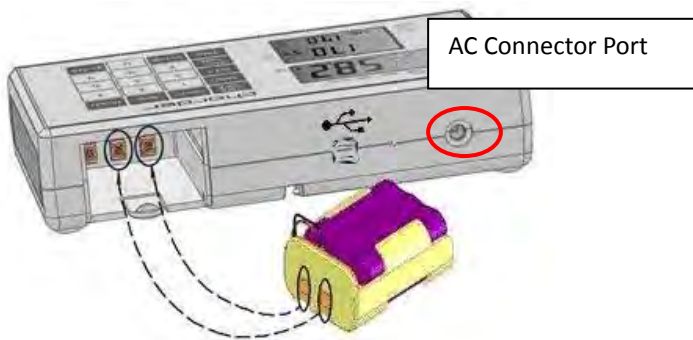

If Lo prompt displays on the LCD, please charge battery promptly to avoid battery damage.

D. Using Adapter

1. Connect adapter to indicator before connecting to mains power supply
2. Disconnect adapter from mains power supply before unplugging adapter pin from indicator.

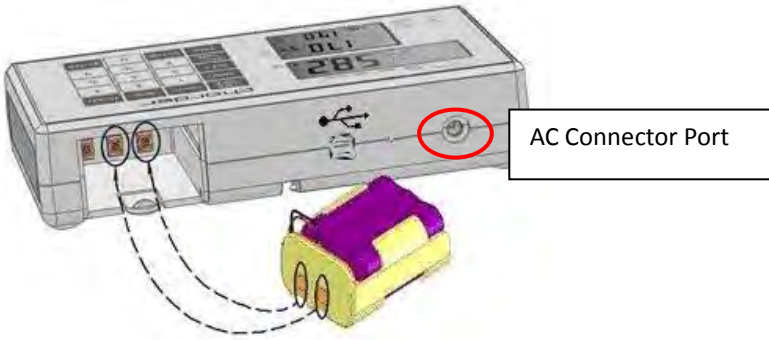









III. Indicator



A. Indicator and Key Functions



(Wireless functionality optional)

Key Function

1.  **ON/OFF**: Power on or power off.
2.  **ZERO**: Reset display to 0.0 kg display. Press and hold for 3 seconds to enter device settings.
3.  **M1-5**: Saving pre-tare values (up to 5)
4.  **PRE-TARE**: Pre-tare the known weight of an object (ex: chair) before beginning measurement.
5.  **TARE**: Allows user to deduct weight from reading after measurement
6.  **PRINT**: When printer or PC is connected to the scale, press this key to print results
7.  **BMI**: Calculation of Body Mass Index
8.  **HOLD**: Determine stable weighing value - used when weight is unstable. Press and hold for 3 seconds to enter time setting.
9.  **0-9**: For entering digits.

- 10.  CLEAR: Clear incorrect data input.
- 11.  ENTER: Confirm input

B. Display layout

Unit Mark (kg)
Indicates that the weight is shown in pounds

Power Index
100% → 75% → 50% → 25%



The main display features a digital scale showing '100000' with 'kg' to the right. Above the display are indicators for 'POWER', 'PRE-TARE', 'HOLD', and 'NET WEIGHT'. On the left side of the display, there are icons for a power button, a tare button, and a battery level indicator.

Unit of height (cm)
Indicates that the height is shown in centimeters

BMI
Body Mass Index is a height to weight ratio, and is calculated by the following formula



The secondary display shows '888.8' with a right-pointing arrow and 'cm' to the right. Below it, it shows 'B.M.I. 88.8'.

Definitions

- Stable symbol:** Indicate that weight is stable.
- Zero symbol:** Weight is at zero
- Negative weight:** Weight under zero.
- Low battery:** Battery needs to be charged or replaced.

IV. Using Device

A. Basic Operation

Switch on the device using  key. The device will automatically perform self-calibration, displaying software version.

Once "0.00 kg" appears on indicator, device is ready for measurement.

Note: If "0.00 kg" does not display on indicator, press  key to zero the device.



Guide subject to sit on chair. Make sure subject's feet are off the ground, and properly placed upon footrests. After the weight has stabilized, the "stable" symbol will appear on indicator.

Note: If subject's weight exceeds scale capacity, indicator will display "Err" prompt due to overload.

B. Hold

The hold function determines average weight, designed to be used if subject's weight will not stabilize (ex: an active child).



Note: if fluctuation is too severe, average weight determination will be difficult and hold may not function correctly

1. Switch on the device normally.
2. Press the  key. "HOLD" will be displayed on the indicator.
3. Guide subject to sit on chair.
4. After a few seconds, the average weight will be displayed on the indicator. This weight will be locked - at this point, subject can stand up from chair.
5. To release the locked weight, press the  key again to return to the device to normal mode.

Note: Hold function can be activated before or after subject sits in chair. However, if subject finds it difficult to sit still, we recommend activating Hold after subject is seated.

C. BMI

1. In normal mode, press the  key to enter BMI mode.

2. Display will show last recorded height. Left-most digit will flash.
3. Enter height using numeral keys (ex: 170 cm). Input will automatically move to next digit. Press  key to re-input. Press  key to manually move to next digit.
4. After inputting height, press  to confirm.
5. Proceed to weigh subject as usual. Indicator will display weight, height, and BMI.

NOTE: Hold function can be used at this time if weight is unstable



6. Press  key to return to normal mode.

Category	BMI (kg/m ²)	Risk of obesity-related disease
Under	< 18.5	Low
Normal	18.5-24.9	Average
Over	24.9-29.9	Slightly Increased
Obese I	30.0-34.9	Increased
Obese II	35.0-39.9	High
Obese III	> 40	Very High

(World Health Organization adult BMI standards)

D. Tare

The tare function allows the user to deduct the weight of objects from the device's measurement result.

1. Place object that needs to be tared onto measurement platform.
2. Press  key after stable symbol appears on indicator. Display will indicate "0.00 kg".
3. Guide subject (plus tared object) to sit in chair. Conduct measurement.
4. To clear tare value, remove all objects from measurement platform, and press  key.

E. Pre-Tare





The Pre-Tare function is used to subtract the known weight of a substance prior to weighing. The device can store 5 sets of pre-tare values.

Pre-tare values can be stored using two different methods: "Load









Weight", or "Input Manually".

After pre-tare weights have been stored, they can be recalled by holding the  key for 3 seconds.

A. Load Weight

DESCRIPTION	EXAMPLE
<p>Press  key after loading weight on the platform; the indicator will display blinking "m" symbol.</p>	
<p>Press numeral key 1 ~ 5 to assign this number with the current pre-tare weight.</p>	
<p>Press  key to store pre-tare weight; the indicator will make a beep sound.</p>	

B. Input Manually

DESCRIPTION	EXAMPLE
<p>Press  key. Left-most digit will begin blinking.</p> <p>If no further action is taken within 6 seconds, indicator will return to normal mode</p>	
<p>While digit is blinking:</p> <p>Enter pre-tare weight using 0~9 keys.</p> <p>Ex: to pre-tare 5.0 kg of weight, press 0-0-5-0.</p> <p>Ex: to pre-tare 13.5 kg of weight, press 0-1-3-5.</p>	
<p>Press  key to confirm the pre-tare weight.</p>	
<p>Indicator will display minus sign to the left of pre-tare weight value.</p>	
<p>To save this pre-tare weight value in memory:</p> <p>Press  key; the blinking "m" symbol will appear on the display.</p>	

Press numeral key 1 ~ 5 to assign this number with the current pre-tare weight.



Press  key to store pre-tare weight; the indicator will make a beep sound.



C. Recall Pre-Tare Weight

DESCRIPTION

EXAMPLE

Press and hold  key for 3 seconds. Indicator will display pre-tare value M1 first. The pre-tare value will flash.



Press numeral keys 1 ~ 5 to choose pre-tare value

Press  key to confirm which pre-tare weight to select; the device will automatically deduct pre-tare weight.



Press  key to return to Normal Mode



NOTE: Pre-tare weight must be under max capacity, otherwise screen will show 0.00 after  key is pressed, and the operator will have to re-input pre-tare settings.

F. Print

If thermal printer is connected to indicator, results can be printed by pressing  key.

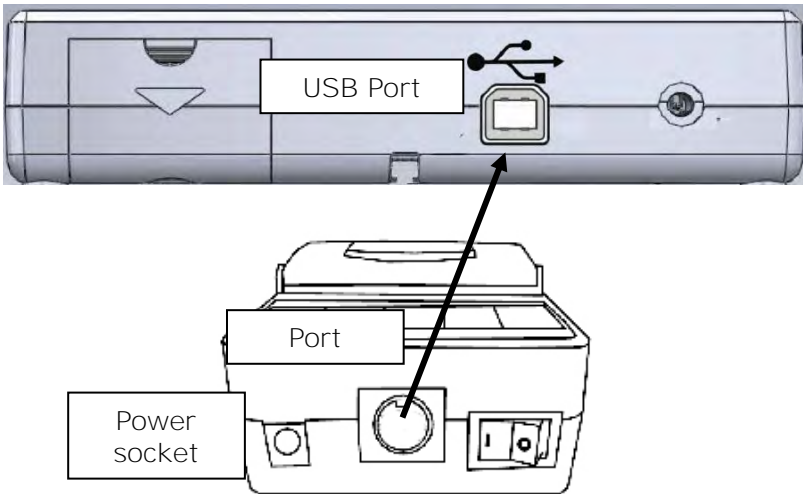









NOTE: Thermal printer needs to be powered by adapter

V. Device Setup

A. Setting Time & Date

Press and hold  key for 3 seconds to enter Time Setting mode.

Example: Inputting 2008, Dec 25, 8:00am

	<p>Year Setting Enter year using numeral keys 0-9.</p> <p>Press  key once completed to proceed to month & date setting.</p>
	<p>Month & Day Setting. Enter month, followed by day using numeral keys 0-9.</p> <p>Ex: December 25th is "12.25". Input 1-2-2-5.</p> <p>Press  key once completed to proceed to time setting.</p>
	<p>Time Setting Enter time (24hr format) using numeral keys 0-9.</p> <p>Ex: 08:00am is input by pressing 0-8-0-0.</p> <p>Press  key once completed to confirm time settings and proceed to confirmation.</p>
	<p>Device will display new time and date settings, cycling between year, month & day, and time.</p> <p>YYYY→MM.DD→: HH:MM</p> <p>Press  key to return to normal weighing mode.</p>

B. Device Setup

When the device is switched on, press and hold the  key for about 3 seconds, until the display shows **the "SETUP", followed by "A.OFF"** (first option in setting menu).

In device setup menu:



to toggle next menu option





to toggle previous menu option



to confirm selection / enter submenu





Auto Power-Off: Instruct device to shut off automatically after a certain period of time.

Press  to toggle between options (120 sec / 180 sec / 240 sec / 300 sec / off), and  to confirm selection.





Buzzer/Beep:

When function is turned on, beeping noise will be made when: indicator is turned on, keys are pressed, and weight is stable.

Press  to toggle between on/off, and  key to confirm selection.





Hold Stop: When Hold Stop is "on", Hold will deactivate after subject leaves measurement platform.

Press  to toggle between on/off, and  key to confirm selection.



LANGU

Language: Set thermal printer language

Press  to toggle between English, Italian and Polish. Press  key to confirm selection.

Font

Font size: Set thermal printer font size.

Press  to toggle between normal and double (larger). Press  key to confirm selection.

bluetooth

Bluetooth (optional): If device has Bluetooth module installed, Bluetooth function can be turned on or off.

Press  to toggle between on/off, and  to confirm selection.



Wi-Fi

Wi-Fi (optional): If device has Wi-Fi module installed, Wi-Fi function can be turned on or off.

Press  to toggle between on/off, and  to confirm selection.

Wi-Fi Setting

Wi-Fi Setting (optional): If device has Wi-Fi module installed, this option will appear.

Press  to toggle between "Auto" and "PKEY". Press  to confirm selection.

If "Auto" is selected, weight measurement will be automatically sent to connected printer or device. If "PKEY" is selected, transfer will occur

manually only after  key is pressed.

VI. Setup USB Connection to PC

For successful connection, PC hardware connected to device must be compatible with USB 2.0 or above. Operators should select a USB cable length that is most suitable to the operating environment.

1. Charder Smart Data Manager can be used to connect the device to a PC. The software program can be downloaded from the Charder website:

[LINK URL] <https://www.chardermedical.com/download.htm>

2. Connect USB cable to device indicator and PC. Follow installation instructions.

Program Setup

1. After installation of Charder Smart Data Manager is complete, software will automatically search for COM port. Press **[Connect]**. Once connected, **[Connect]** button will change to **[Disconnect]**.

Charder Smart Data Manager COM [] Connect

Gross Weight	0.0	kg	First Name	Enter
Tare Weight	0.0	kg	Last Name	Enter
Net Weight	0.0	kg	Patient ID	Enter
Height	0.0	cm	Date of Birth	31 / 12 / 1990
BMI	0.0		Gender	Male Female

Data

Please press "Connect":
Update Time:
Model:

Conducting Measurement

1. Input subject's first name, last name, patient ID, date of birth (DD/MM/YYYY), gender, and height (for BMI calculation) into software if needed. Press **[Clear]** to clear all input.

NOTE: information can also be input after weight measurement.

The screenshot shows the 'chorder Smart Data Manager' interface. On the left, there are input fields for 'Gross Weight' (0.0 kg), 'Tare Weight' (0.0 kg), 'Net Weight' (0.0 kg), 'Height' (167.0 cm), and 'BMI' (0.0). Below these is a 'Data' section with 'Auto' and 'Manual' buttons. On the right, there are input fields for 'First Name' (Jane), 'Last Name' (Doe), 'Patient ID' (20190201), 'Date of Birth' (31 / 12 / 1965), and 'Gender' (Male/Female). At the bottom, there are 'Collect', 'Clear', and 'Save as' buttons. A status bar at the bottom left says 'Please press "Connect". Update Time: Model:'. A 'Connect' button is in the top right.

2. Conduct measurement. If **[Auto]** is selected, results will be transmitted from device to software automatically and displayed on the left of screen. If **[Manual]** is selected, user must press "Collect".

The screenshot shows the 'chorder Smart Data Manager' interface after a measurement. The 'Gross Weight' is now 72.5 kg, 'Net Weight' is 72.5 kg, and 'BMI' is 26.0. The 'Height' remains 167.0 cm. The 'Data' section now has 'Auto' selected. The 'Collect' button is now disabled. A status bar at the bottom left says 'Data updated. Update Time: 06/03/2020 11:40:05 Model:'. A 'Disconnect' button is in the top right.

Saving & Printing Results

1. Press **[Save as]** to save measurement results as .csv file on PC. Default file name is same as user ID. (ex: 20190201.csv) To track changes and multiple measurements for the same subject, we recommend not changing the default file name.

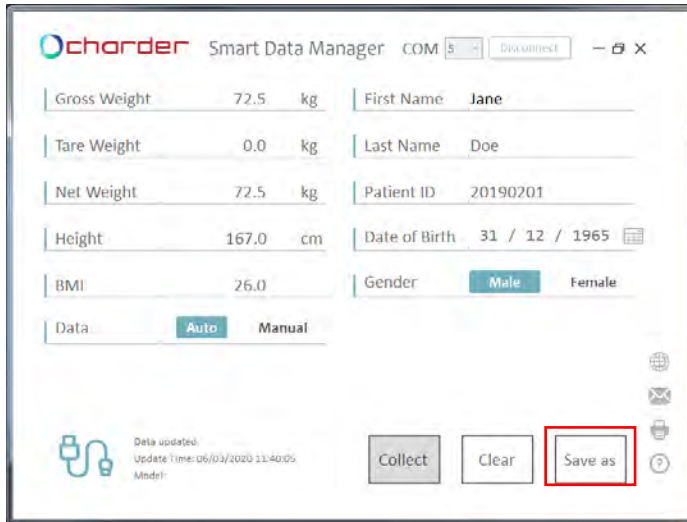

2. Result example:

	A	B	C	D	E	F	G	H	I	J
1	Patient ID	First Name	Last Name	Date of Bi	Gender	Gross Weig	Tare Weight	Net Weight	Height	BMI
2	20190201	Jane	Doe	31/12/1965	Male	72.4 kg	0.0 kg	72.4 kg	167.0 cm	26
3										
4										
5										

If previous results were saved in "20190201.csv", new results also need to be saved as "20190201.csv" (overwriting old file) in order to save multiple results for the same subject.

	A	B	C	D	E	F	G	H	I	J
1	Patient ID	First Name	Last Name	Date of Bi	Gender	Gross Weig	Tare Weight	Net Weight	Height	BMI
2	20190201	Jane	Doe	31/12/1965	Male	72.4 kg	0.0 kg	72.4 kg	167.0 cm	26
3	20190201	Jane	Doe	31/12/1965	Male	75.2 kg	0.0 kg	75.2 kg	167.0 cm	27
4										

Results will be saved in chronological order of measurement.

3. Press the printer icon to print out result using a printer connected to the PC.

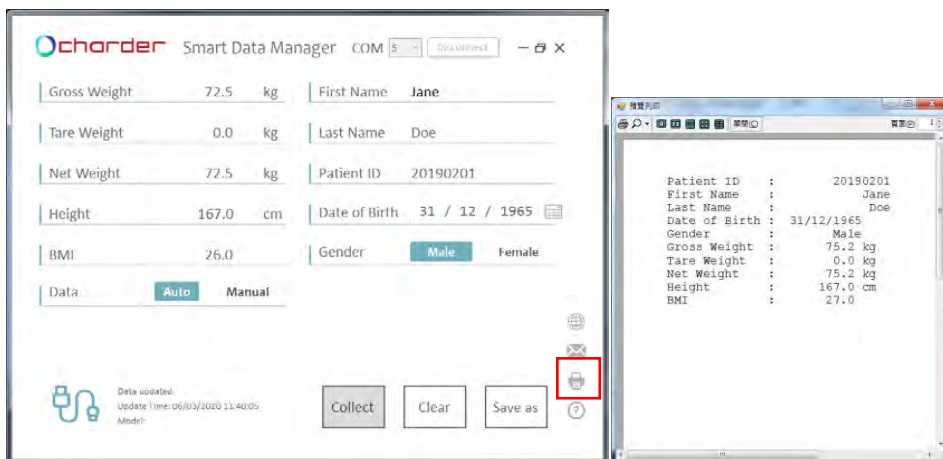

VII. Wireless Connection

If the device has the wireless module installed, the indicator can transmit measurement results wirelessly. Please see Charder wireless software instructions for details.

VIII. Troubleshooting

Before contacting your local Charder distributor for repair service, we recommend considering the following troubleshooting procedures:

Self-inspection

1. Device will not power on

- If battery power is depleted, replace with new batteries
- If batteries are not used, check if the power adapter is plugged into the device properly. Check if power adapter is plugged into mains properly

2. Indicator showing "0000" ZERO SPAN out of range

- Interference due to factors such as RF disturbance or ground vibration. Relocate device to location without interference and try again
- Unstable platform feet - adjust wheel level according to bubble level indication and try again
- External objects interfering with measurement platform. Clear platform of objects and try again
- Device may not function properly on soft surfaces such as carpets or lawns. Relocate device to location with solid, stable floor
- If the steps above cannot resolve the problem, re-calibration may be required to correct weighing accuracy

3. Connection failure for data transmission to PC or printer

- Ensure wires are connected correctly between indicator and PC or printer
- Ensure printer is supplied with power. Ensure PC software is set up properly as indicated in this manual

Distributor support required

If the following errors occur, we recommend contacting your local Charder distributor for repair or replacement services:







1. Device will not power on

- Faulty on/off key
- Broken or damaged wires causing short circuit or faulty connection
- Safety fuse burnout
- Faulty Adapter

2. Indicator damage

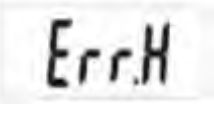
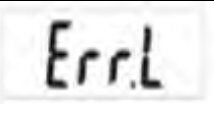
- Possible hardware defects include: uneven brightness in LCD screen, blurred text, smeared rainbow screen, incorrect decimal display
- Unable to save or read data
- Indicator shows "ERRL" after device is switched on
- Keys not responding
- Buzzer malfunction

Error Messages

Error Message	Reason	Action
	Low battery warning Voltage of battery is too low to operate device	Replace batteries, or plug in adapter
	Overload Total load exceeds device's maximum capacity	Reduce weight on measurement platform and try again
	Counting Error (too high) Signal from loadcells too high	Error normally caused by faulty loadcell or wiring. Please contact distributor
	Counting Error (too low) Signal from loadcells too low	Error normally caused by faulty loadcell or wiring. Please contact distributor
	Zero count over calibration zero range +10% while power on	Re-calibration required. Please contact distributor
	Zero count under calibration zero range -10% while power on	Re-calibration required. Please contact distributor
	Program Error Fault with device software	Error normally caused by faulty loadcell or wiring. Please contact distributor

IX. Product Specifications

Model		MS5440
Display		DP3710
Weight Measurement	Capacity	300 kg x 0.1 kg
	Accuracy	± 1.5e
	OIML	Class III
	LCD Screen	1.0-inch LCD screen (5 1/2 digits)
Dimensions	Overall	690(W) x 1235(D) x 945(H) mm
	Seat	Height: 540mm Width: 560 mm Back Height: 450 mm
	Armrest	Height: 700 mm
Device Weight		23 kg
Key Functions		On/Off, Zero, Print, BMI, Hold, Pre-Tare, Tare, Clear, Enter, 0-9, M1-5
Data Transmission		USB, Wireless Module (optional) NOTE: Device should be connected to network by qualified distributors only
Power Supply		Rechargeable battery pack (optional) or 6 AA batteries / Power adapter
Operation Temperature & Humidity		0°C~40°C 15% / 85% RH
Standard Accessories		User manual*1, Power Adapter*1, USB transfer cable*1
Optional Accessories		Thermal Printer, Height Meter



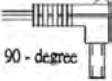

Warning

The device is only compatible with the power adapters listed below:

AMP VOLTAGE	DRAWING NO.	CE APPROVED TYPE NO. / MODEL NO.	TYP E	Adapter plug
12V 2A	AD-8058(AD-0521)	UE24WU-120200SPA	US	 90 - degree
	AD-8057(AD-0520)	UE24WV-120200SPA	EU	
	AD-8056(AD-0519)	UE24WB-120200SPA	UK	
	AD-8074(AD-0534)	UE24W4-120200SPAS	AU	

X. Declaration of Conformity

This product has been manufactured in accordance with the harmonized European standards, following the provisions of the below stated directives:

	93/42/EEC as amended by 2007/47/EC Medical Device Directive
	2014/31/EU Non-automatic Weighing Instruments Directive

Please see separate document showing on sticker of device for above CE marking.

Authorized EU Representative:



Obelis s.a.

Bd Général Wahis, 53
B-1030 Brussels
Belgium



Manufactured by:
Charder Electronic Co., Ltd.
No.103, Guozhong Rd., Dali Dist.,
Taichung City, 41262 Taiwan (R.O.C.)

CD-IN-1262 14209J 03/2021